

Important Notes

This fingerprint machine is designed to work with the newly issued V3.X version Time & Attendance software only, which full compatible with the original V2.X version that has been popularly applied to all machines, the new one own the stronger function, the more convenient, and more human nature for user than the V2.X version

Acknowledgements

Thank you purchasing our product, before working with this machine, please read this manual carefully

Notice

Please do not place the product in the place with strong light, because the strong light may significantly affect the fingerprint scanning, and thus cause the fingerprint verification fail. This product is designed for indoor installation, if it has to be installed it outdoor, please place the equipment in proper environment, you must beware of not exposing it to wet or harsh condition, the product work temperature rang is 0-40°C. Do to use you machine in every hot environment, keep you machine away from the heat source and radiator. For long time use it outdoor and the internal heat of the machine, will cause problem to the operation

Notice: Fingerprint Enrollment and Identification shall be taken after the installation the fingerprint identification machine



Installation

Enrollment

Identification



Enrollment

Installation

Identification

How to place the finger

Make sure the fingerprint image captured is of a core of presented finger, a fingerprint is point to locate within innermost recurring ridge of any give finger.

To obtain a higher success rate, enroll same finger 3times in a slightly adjust angle, one to the center, one incline slightly to the left. The third incline slightly to the right. You follow the following place procedure; the success rate will increase dramatically

The correct way is:

Place a finger flatware on the sensor surface

Place it to the center of the sensor surface

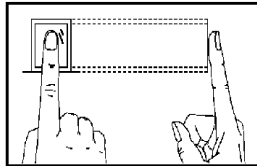

The wrong way is

Vertical

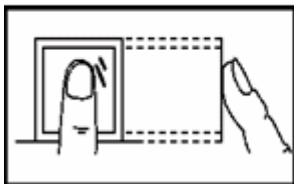

Offset

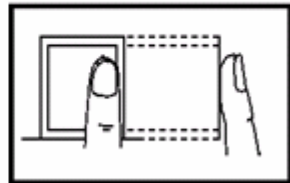

Inclined

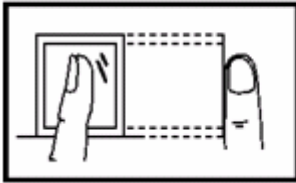

Lower

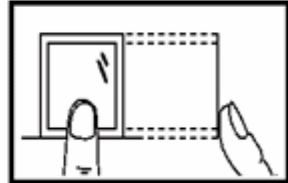

Notice: Please adopt the correct way to place the finger; Our Company is not liable for any damages and troubles whatsoever arising out of from improper pressing manners.

About this Manual

All functions in this document is subject the actual product , as a result of the product is unceasing renewal, all attempts have been made to make the information in this document complete and accurate. Our company **is not responsible for** the actual product is consistent with this material, is not liable for any direct or indirect damage or loss of business resulting from in accuracies or omissions, the specification in this document are subject to change without notice

Recommendation step

Step 1: Place the fingerprint machine properly and power up machine.

Step 2: Enroll user, register fingerprint and password, and assign privilege to user.

Step 3: verify user, by the registered fingerprint and password is available.

Step3: Configure the communication parameter; download the staff information to software using the U flash disk or one of three ways

which is used to connect with the computer.

Step 5: Revise the staff's information in the staff maintenances item of software, connect the equipment with PC again and upload the staff information to the equipment, at this time when the fingerprint machine track staff's Time & Attendance log , his/her name will be display on the screen.

Step 6: Make a check for the fingerprint machine time, whether it is correct, after completing setting up, then start to track employee's attendance.

Step7: At end of the month the downloaded attendance log to software will be accounted.

The equipment is at the ready working status

After user verification completed by the fingerprint or the password the attendance log will be saved in machine general

Readiness for work

The equipment is in readiness for work, shown as following picture:



Under the readiness for work, the advertising picture may be uploaded by use self (please sees on 6.4 upload definition picture), also may configure the clock setting (please see 4.5 interfaces setting).

What's in attendance condition?

Mode 1

When the equipment is at the readiness for working, press the condition key on the equipment to shift the attendance condition, and the states information that correspond the condition key general display on the screen, the condition of your choice shown as orange color . Press the ESC key prompt information disappear. The definition of the default condition key in the equipment, please see 4.4 keyboards definitions.

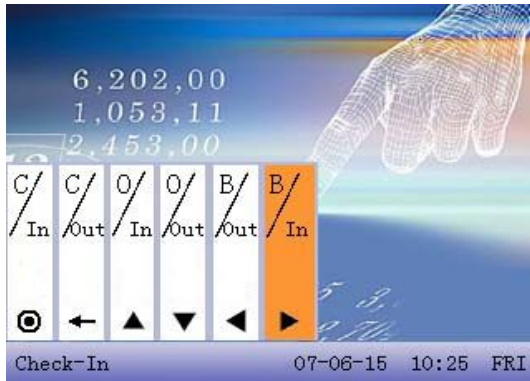

Mode 2

It is allowed to set up a number of state that is self-definition and therefore when press button, do not indicate the state prompt information, in the lower left-hand corner only shift the corresponding state.

Track Time & Attendance

The attendance record will unable to be saved to the machine until user verifies successfully with her/his the fingerprint or the password.

◆ Track Time & Attendance by Fingerprint

(1) 1: 1 fingerprint validation (AC.NO +fingerprint)

Match the fingerprint which place the fingerprint sensor face and type the one relate the number with keyboard entry, when user's fingerprint quality is poor too recognize, this way 1: 1 will be used.

Step 1: Verify personnel's AC.NO that keyboard entry in the initial interface.



Step 2: Place finger on the sensor window in properly way

Step3: The equipment prompt "thanks", the validation process completed. When the equipment prompts "please place finger again ", go back to repeat this operation.



(2) 1: N fingerprint validation

Match the fingerprint which is created by user press finger on the

sensor face and all fingerprints data in fingerprint machine

Step1: Press the fingerprint sensor with finger in proper method.

Step2: The equipment prompt "Thanks", the validation process completed.



Step3: The equipment prompt "please place finger again ", go back



to repeat operation.

◆ **Track Time & Attendance by password**

Step 1: Entry AC.NO belong to personnel who need to be verify in the initial interface, press "OK" key

Step 2: If prompt the registered number is wrong, that means there is no this personnel's number; if the prompt does not jump to the password interface after press "OK" the key, mean this staff has not registered the password.



Step 3: the password interface appears, please input the password



Step 4: The equipment prompt "Thanks", the validation process is completed.



The equipment prompts "the password is wrong", than the step repeat operation.



About Access Control

After complete to assign The Access Control privilege, when the staff go on authentication on the equipment, the equipment will determine whether staff own privilege to open the door. If employees do not meet conditions to unlock, the equipment will be given corresponding prompt, the following by fingerprints to verify as an example:

1. Equipment motion that verification is successful, and output a unlock signal.



2. The equipment prompt the Time Period is invalid.



This current time is without the Time Period employees is allowed to open the door . Therefore, the staff could not open the door.

3. Prompt the invalid Group combine appear by the equipment.



This group where the staff locates is without unlocking combine. Therefore, the staff could not open the door.

4. Motion to go on multi-user certification.



Until the group where user locates and the other group pass certification together, it is not allowed to open the door.

5.The equipment motion to combination verification.



This is verification through the user or the group the users locate combine verified, it is need to verify identity by multiple verification

Connect with PC

This equipment will only track the attendance time record, to get statistics result is unable till the software process the attendance record in the PC, therefore the need to connect machine with PC to download attendance logs into Time & Attendance tracking software.

There are several ways to connect the machine and Time& Attendance tracking software:

◆ Ethernet

(1) Via the Hub: With Straight Thru Cable (apply to connect network card and Hub) turns on, connect fingerprint machine to network.

(2) directly Connection: With T crossover cable (directly connect two Ethernet terminal) connect fingerprint machine to PC

Machine Option: Enters the menu - communication Option, please set the following several items:

IP address: default IP is 192.168.1.201, as your need change setting

Subnet mask: default Subnet mask is 255.255.255.0, you may change it depending on actual need.

Gateway: the default gateway is 0.0.0.0, you may change it depending on actual need

Network speed: The network run speed, there are automatic adaptation, 10M, the 100M three options;

Connection password: in the “connection setting”. May change communication parameter, after setting, input the corresponding value on connection interface in the PC software.

◆ **RS232 way**

Machine setting: Enter the menu - communication option, please set the following several items:

Baud rate: With the computer communication speed, the high speed communication is quick, it is better to use the RS232 communication; (115,200, 57,600).

RS232: Whether uses the RS232 communication, set this item as “Yes”

Communication password: in the “connection setting”. May change communication parameter, after setting, must input the corresponding value on connection interface in the PC

◆ **RS485 way**

Machine Setting: Enter the menu – communication option, please set up the following several items:

Serial number: Assign a network ID. The serial number scope is 1 – 254.

Baud rate: the computer communication speed, the low speed communication is stable, we recommend that the RS485 communication Baud rate as (9,600, 38,400)

Whether uses the RS485 communication, set this item as “Yes”.

RS485: Communication password: in the “connection setting”. May set it or do not set it, after setting, must input the corresponding value on connection interface in the PC.

◆ **USB way**

Machine Setting: Entering the menu - communications settings, set up following several Options:

Machine No: set it in the "Connection option". The number of machines, Scope the 1-254;

USB: whether use USB communication, choose this item to yes.

Communications Password: set it in the "Connection option". Maybe set it up or not, after set up ,input the corresponding figure in the PC-Link software interface .

Contents

1 Main Windows	1
2 User Management	1
2.1 Add new user	2
2.2 Users management.....	6
2.3 Short message ★	17
2.4 work codes★	23
2.5 Access Control setting ★	26
2.6 Card management★	40
3 Communication setting.....	48
3.1 Configure networks	49
3.2 Configure serial port.....	50
3.3 Setting up connections.....	52
3.4 WiFi Setting★	53
3.5 Wirless LAN★	57
3.6 Wiegand★	58
4 System Setting	63
4.1 Systems parameters	63
4.2 Data managements.....	65
4.3 Upgrade firmware.....	67
4.4 The definitions of keyboards★	68
4.5 Window Setting	72
4.6 Restore setting	74
4.7 Bell setting★	75
4.8 Misc Setting.....	76

5 Time date	79
5.1 Time and Date settings	79
5.2 Daylight Saving Time	80
6 USB Flash disk management	82
6.1 Download attendance datum.....	82
6.2 Download user's data	83
6.3 Download SMS★.....	84
6.4 Upload the user data	84
6.5 Upload SMS★	84
6.6 Upload the customized picture	85
7. Automatically test	87
7.1 Test TFT screen	87
7.2 Test pronunciations	88
7.3 Test keyboards	88
7.4 Test fingerprint Sensor.....	88
7.5 Real-time clocks	89
8. Inquiry record	90
8.1 Inquiry attendance	90
9. Systems information	93
9.1 Logs capacity	93
9.2 Equipment information	94
Appendix 1 Getting familiar with keyboard.....	95
Appendix 2 T9 input method★	100
Appendix 3 Multi-combination Authentication Mode ★	103

Appendix 4 Quickly inquiry the staff attendance logs..... 109

Appendix 5 The rule about the advertising pictures.....111

Appendix 6 anti-pass back function ★ 112

Appendix 7 Photo ID ★ 116

1 Main Windows

The fingerprint machine is in readiness state, Press **Alt+F4** key to open the main window, shown as following figure.



2 User Management

For a fingerprint machine, user's basic information includes fingerprint, password and management privilege. When the company track staff Time & Attendance log , as a result of reassign staff, the user information in the fingerprint machine also needs to correspondingly make the modification, therefore the fingerprint machine provide function to add, delete, search, change user and so on the operation.



2.1 Add new user

Firstly register the personnel's fingerprint or the password on the machine. Whose time & attendance record will be tracked, Enter the interface to add new user:

The image is a screenshot of a 'New user' registration window. The window title is 'New user'. It contains the following fields and controls:

- 'AC. NO' field with the value '1'.
- 'Name' field.
- 'FP' section with 'Enroll FP' and 'FP Num:0'.
- 'PWD' section with 'Enroll Pwd'.
- 'Purview' dropdown menu set to 'User'.
- 'OK (M/↵)' button at the bottom left.
- 'Back (ESC)' button at the bottom right.

AC.NO: Staff's attendance number.

Name: use T 9 input method to keyin user's name.

Note: only except iClock 100 fingerprint machine

Fingerprint: Registered staff's fingerprint, register ten fingerprints available

The registered fingerprint staff is possible to use the fingerprint to check attendance.

Registration password: The registration user's password, the effective figure of password is 1 ~ 8.

The registered password staff is possible to use the password to check attendance.

Privilege: Users are people whose identity must be authenticated before enter a menu. The ordinary consumer can track attendance by the fingerprint or the password only; the manager already may equally carry on the daily checking attendance with the ordinary consumer, but may enter the menu to operate each option.

Note: When there is no established the manager, any person all may enter the menu operation; after establishing the manager, be unable to enter the menu until the manager status is confirm, after the success can enter the menu.

Example: the flow to add user as follows:

Input AC.NO

- 1) The equipment is assigned AC.NO by default.
- 2) Press the "←" key to delete the default assigned AC.NO, when

entry AC.NO with the keyboard, if occur error. May press "←" to delete it and input AC.NO again. Directly press "OK" key or scroll the ▲/▼ key, and locate cursor on the "Enroll fingerprint" button to press the OK key again, go on the fingerprint registration.

Name

use T9 input method to key in user's name.

Registration fingerprint

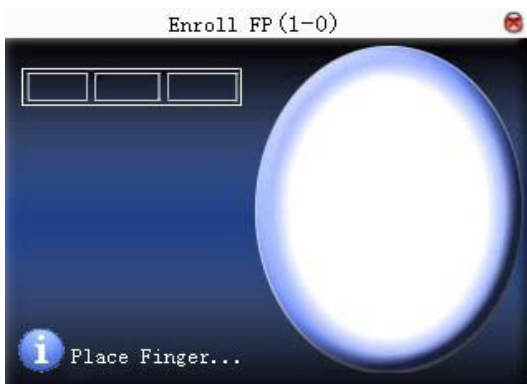

Follow the equipment prompt place the finger, you must continuously press the same finger 3 times in the correct method until the registration success prompt appear.

After registered the fingerprint successfully, if need to continue register the fingerprint, please press the OK key , then place another finger again, after registration completed, directly press "M/←", "ESC" key to return the main interface, the equipment can show the number of fingerprint which presently has been already registered.

scroll the ▲/▼ key, and locate cursor on the "Enroll Password"

button to press the OK key again, go on the Password Registration "the registration password" on the button.

Password registration

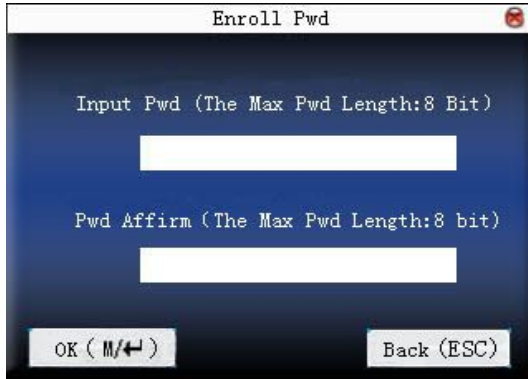

Following the equipment prompt, input the password , then press OK key and input password once again , only can input 1 ~ 8 the effective figure for the password . After the input to save completed press "OK", if does not save it, press "ESC".

After saving it, the icon  will display on the screen, which mean the password has already set in the device.

Privilege setting

Scroll the▲/▼ key, and locate cursor on the "Privilege" option box, Scroll ◀/▶ key to choose privilege.

Save/exit user registration

To confirm the registration information is correct, after getting

confirmation, save it.

The way for saving:

1) Press "⏪/⏩" the key or scroll ▲/▼key to locate cursor on the "completes (⏪/⏩)"button, please press "OK" key again, the prompt "the data has been changed, Are you sure to save it?" on the equipment, press "OK" the key to save it, if you do not want saving, press "ESC" to exit. If the prompt "Save successfully! Continues to input?" appear on equipment, want continuing to press "OK", if you abandon this operation, press "ESC" key.

2) Press the ESC key or scroll ▲/▼key to locate the cursor on the "return (ESC)"button, please press "OK" key again, the prompt "the data has been changed, Are you sure to save it" appear on equipment , press "OK" key to save and return to the preceding of menus, does not serve and return to the preceding of menus, press "ESC" key.

2.2 Users management

By means of the user management you can view all users' information in the current equipment is available, which include username, the number of fingerprint, whether the password is registered, and user's attendance logs. You are allowed to edit or delete some user.

AC_NO	Name	FP	PWD
1		2	
2		2	🔑
🔒 3		1	
10001		2	
20001		0	
20002		1	
20003		2	🔑
20004		0	🔑

PageUp: * PageDown: # Edit: OK Func: M/↵

Note: 1) Shown as above figure, the icon 🔒 express that this staff is a manager, the icon 🔑 express that the password has been already registered.

Press the "M/↵" key in above figure, the following menu: pop-up



scroll the ▲/▼ key to enter your choice.

2.2.1 Search for users

When there are lot of registered user in the device, in order to provide

the manager with convenient rapidly to find a staff, the equipment come with "AC.NO" to retrieve the staff.

Press the "**M/←**" key in the user management interface, the operation menu appear, choose "search user". Or key in any numeric on the keyboard:

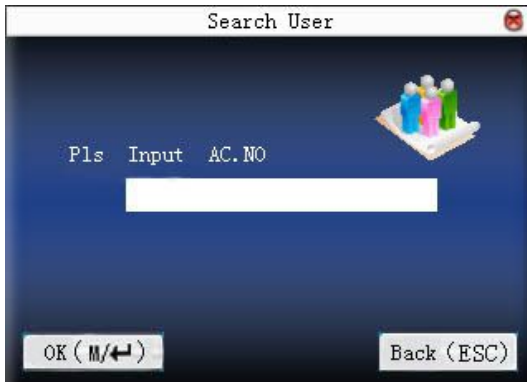

Input staff's AC.NO you search for, press the "OK" key to search, after searching successfully, the blue cursor will automatically locate on this staff name, if this staff you search does not exist in the device, the prompt "the non- registration data" will appear.

2.2.2 Inquiries Attendance

When the manager examine staff's registration information and fingerprint so on, meanwhile may track the staff attendance record in the same month.

Press the "**M/←**" key in the user management interface, the operation

menu appears, choose "Attendance inquires" item, may track the staff's that you choose the attendance record in the same month:

Date	Attlog	AC_NO:1
05/07	07:20 12:03 13:28 18:02 18:59 21:14	
05/08	07:55 11:58 13:40 18:11	
05/09	08:00 12:20 13:21 18:05	
05/10	07:54 12:08 13:09 18:22 19:10 22:00 22:01	
05/11	07:40 09:10 09:11 09:11 10:00 12:03 13:21 18:20 19:35 21:40	
05/12	07:52 12:21 13:25 17:47	
05/14	07:56 12:01 13:24 18:53	
05/15	07:30 12:12 13:30 18:20	
05/16	07:47 12:20 13:27 18:01 18:40 21:26	

PageUp: * PageDown: # Detail Rec: M/↵

Scroll ▲/▼ key to browse the attendance log line by line.

Press PageUp/PageDown key to browse the attendance log page by page.

Press OK/M/↵ key to inquire the detailed situation.

AC_NO	Name	ATT	Verify	State
1		05/07 07:20	F	1
1		05/07 12:03	F	0
1		05/07 13:28	F	2
1		05/07 18:02	F	3
1		05/07 18:59	F	6
1		05/07 21:14	F	7

Record Num. : 6 F: FP S: CheckIn

After the examination completed, press "ESC" key to return to the user

management interface.

2.2.3 Editions users

Makes the revision for user's information which have been saved in the machine, for example, if the registered fingerprint is invalid , renew the registration fingerprint or register the password, just enter the " edition user" available.

In the user management interface, scroll ▲/▼ key or utilize “searching user” to designate staff who need edit , then press the "M/←" key to choose the " edition user" in the operation menu; Or press quick key **OK**; display the user’s information which has been registered:



The AC.NO is not allowed to revise again, other operations is similar with to add the user. Register the fingerprint again, if there is not the password or need to revise the password, then directly click on "Chg Pwd", the privilege also is allowed to revise.

Save edition/Exit edition

1) Press "M/←" the key or scroll the▲/▼key to locate the cursor at the completed " (M/←)"button. Press "OK" key again, save editing result and return to the user management interface.

2) press the "ESC" key or scroll the ▲/▼key to locate the cursor at the " (ESC)" button , press "OK" key again, prompt "the data have been changed, are you sure to save it" display on the equipment press OK, press “ ESC” key to abandon operation

2.2.4 Deletions users

The option "deletion user" is to delete staff's partial information or all information from the equipment, which apply to the following situation:

1) The staff's fingerprint or the password is invalid or do not user any more.

2) After the staff lay off, administrator deletes her/his record from the equipment. In the user management interface, scroll the▲/▼ key or search user to locate the blue color cursor at the staff that needs to edit, press the "M/←" key. The operation menu appears, your choice is "deletion user".

Deletion user



If there is not user's fingerprint or the password in the device, then his /her corresponding typeface is a blue color, be unable to operate it, scroll the ▲/▼ key to locate the cursor at the option which need to operate. Press the "OK" key pop-up the dialog box which asks you give confirmation whether delete this item, after confirmation, the equipment should create the corresponding prompt, press "ESC" key to return to the user management page.

2.2.5 Add user

There is an option that is easily operator to add user in the here, the function is some with 1.1 introduce.

2.2.6 User Access Control ★

In the user management interface, Scroll▲ / ▼ keys or search users the blue cursor will be located in the staff who want to be edited, a

single-clock the operation of menu, select "User Access Control."

User Access Control Setting is to set privilege to open the door for each individual . These include: Group-owned setting, verification methods, used Time Period, the verification methods, fingerprints management. Group: registered users will be assigned to the group, it is easily manageable;

Using Time Period

- 1) the group Time Period: the user whether or not use their default the group Time Period.
- 2) Users Time Period: to set up the user unlock time. That is not to use group time, the group does not affect the other people unlock time.

Verification methods

- 1) Group verification types: the user whether use the group verifying types or not.
- 2) Personal validation types: individual users choose the type of verification, or non-use type verification group, the group does not affect other types of verification.

Duress fingerprint management

a newly registered users or specialized appoint a fingerprint which has been registered in the fingerprint machine to the Duress fingerprints. In any case, the fingerprint match successfully, then product the duress alarm.

Note: equipment provides a wide range of types verify, specific See Appendix 3, Multi- verification.

Instructions:

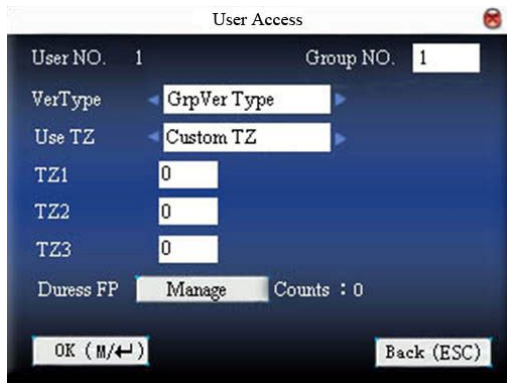

Scroll ▲ / ▼ key to move the cursor to the optional items. If the item is the input box, input the value with the small number of key keyboard, If it is a rolling box, Scroll ◀/▶/ key to switch the provided value, when the cursor posit to "manage Duress fingerprint" button, Press ↵ key to enter the Duress fingerprints management. After completing setting, directly press ↵ or the menu key to save it and return to the previous interface, press the "ESC" to Cancel and return to the previous setting interface .

Duress fingerprints management

No.	Description
<input checked="" type="checkbox"/> 00001-01	the o1 sum of FPs
<input checked="" type="checkbox"/> 00001-02	the o2 sum of FPs

select OK Menu M/←

1) Definition / cancellation Duress fingerprints
 on the above interface, Press the OK key to define / cancel the current Duress fingerprints you selected. Press the menu button.

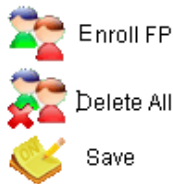

Choose canceled all, cancel all the fingerprints on the current page, Do not serve as the duress fingerprints.

2) Duress fingerprint registration

In the above interface, press the menu button, to choose the "new" option from the menu, then enter fingerprint registration interface, after registering the successfully in the register interface you will find that the fingerprints are designated as Duress fingerprints.

3) Save the duress fingerprints

If confirmed definition of duress fingerprint in the above interface , pres the menu button, option "save." appear in the menu

2.2.7 ID cards ★

Some equipments can also use ID cards to verify identity.

registration ID card

there is a ID card button in the new user interface of the machine with ID cards function:

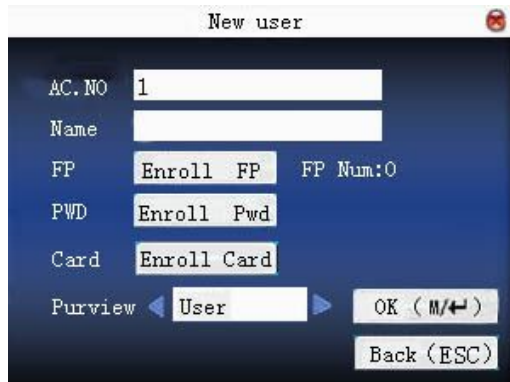

Scroll ▲ / ▼ keys to locate the cursor to the "registration card" button and press Ok key to enter the registration card keys:

Slightly wave the cards near induction area, after when the equipment find the card, then remove the cards from the equipment, by the equipment the card numbers will be readied to save and display on screen. Press ESC key to exit, press Ok button to save and return to confirm interface.

ID card verification

slightly wave the cards near induction area , after when the equipment find the card , then remove the cards from the equipment induction area, if the cards has been registered in this machine on the equipment, the cardholder information will be displayed on the screen.

If the card is unregistered, no registration cards prompt appear.

Note: the card induction area is above fingerprint sensor about the 3 cm -7cm .

2.3 Short message ★

The short message is similar to the bulletin, and the notice. It allowed operator to schedule and edit the content of the short message that will display on the screen. The short message is divided into the public short message and individual short message, if the public short message has been established, the icon  will display on the information bar of the readiness window within the assigned time scope, the default key of the equipment is "#" key (set the keyboard definition available) after press this key to view the short message content. If the individual short message has been established, then the system will distribute the short message to the staff, after the staff track attendance successfully. He/she will able to find the short message.

Instruction



scroll the ▲/▼ key to view the short message in line by line.

Scroll the PageUp/PageDown key to view the short message in page by page.

Press "OK" the key to examine the detailed situation of the short message, cannot change the short message.

Press  key, the short message menu will appear



2.3.1 Establish the short message

1) Add the short message

Scroll the ▲/▼ key to select the "add" choice of the short message in the pop-up menu.

Start time: this time the short message becomes effective.

Effective period: within the effective period the short message will display, after effective period is expired, the short message will not display.

Message type: Individual: only for individual.

Public: All people are able to see.

Initialization: in advance set the short message, the individual or the public short message will not be assigned.

Instruction



When the cursor locate in the text box, open the T9 input method, press the "*" key to input the content of the short message, scroll the ▲/▼ key to switch the input box, scroll◀ /▶to change setting or keyboard and input the value with the small numeric keyboard.

(1) If the type of individual short message is your choice, the distributing button is available; here the individual short message will be distributed to the staff



Scroll the ▲/▼key to search personnel line by line .

Scroll PageUp/PageDown key to search personnel page by page.

Press the "OK" key to choose the personnel who is in the current position, namely that express the short message has distribute to this staff.

Press the M/← key to save your choice and exit.

Note: If before choosing personnel exit, this type of the short message will become the initialization.

(2) If select the type of the public short message or initializes the short message, then the distributing button will be disabled, after setting completed, press M/← key to save and return to the short message list.

2) Edit the short message

Scroll the ▲/▼ key choice "edition" in the pop-up menu to edit the short message.

The operation to edit the short message is same with one to add the short message.

3) Delete the short message

scroll the ▲/▼ key choice " deletion " in the pop-up menu to delete the

short message.

Simultaneously eliminate all related information which is relating with this record.

2.3.2 View staff the short message

1) Examine the public short message

when the equipment is at the readiness status, the main interface show the picture and the current effective content of the public short message, the interval to display time is same with the advertising picture



When the information bar of the machine main interface display the prompt icon , press the "#" key to view the current effective public short message immediately.

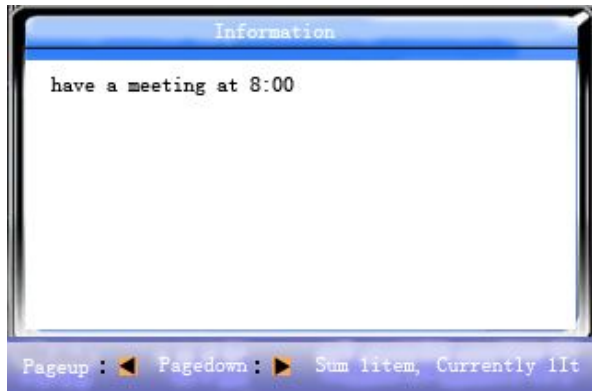

2) Examine individual short message
when user through after confirmation, if this user has the short message
the short message content will be display.



The duration of the message display is 30 seconds, during the display
the user verification is available; close the current display to enter the
verification interface at this time.

2.4 work codes★

Track Time & Attendance record is basis to compute the salary, the staff has possibly assign to the different working category, also has the possibility to be dissimilar kind of work in one factory in the different time, but for the different work category the reward is dissimilar, therefore, the equipment provide user with parameter to indicate tracked record that belongs to kind of working category in a factory, provide convenience and very easy to process time & attendance data ,could fast distinguish the different situation checking attendance.

Instruction

NO.	Name
0	on business
1	Officer
2	Clean room
3	Cut Grass
4	Wash clothes

PageUp: * PageDown: # Edit: OK Menu: M/←

Scroll the ▲/▼key to view work code line by line .

Scroll the PageUp/PageDown key to view work code s page by page.

Press the "OK" key to edit view work code of your choice.

Press the M/←key, the menu to set work code will appear.



2.4.1 Set work code

1) Add the work code

scroll the ▲/▼ key choice "add" in the pop-up menu to add the short work code.

Code: A number word code of this work code.

Name: express the mean of this work code.

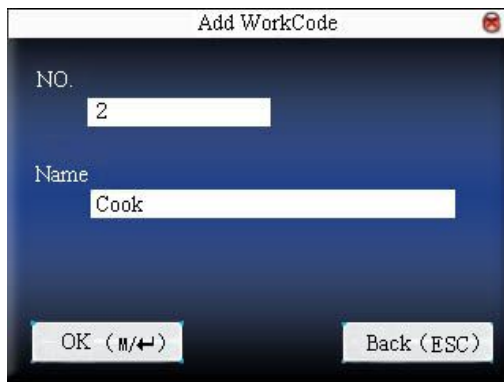

2) Edit the work code

scroll the ▲/▼ key choice "edition" in the pop-up menu to edit the work code.

The operation to edit the work code is same with one to add the work code.

3) Delete the work code

scroll the ▲/▼ key choice " deletion " in the pop-up menu to delete the work code.

Simultaneously eliminate all related information which is relating with this record 2) edit the work code.

2.4.2 Using work code

When the equipment is in the readiness interface, press "*" the key (allowed to set it in keyboard definition) enter the work code selection interface.

code	Name
0	Business
1	Visit doctor

The user may directly input work code, or scroll the ▲/▼ key to select from the work list., press **M/←** to choose it, then press OK key to return main interface.

2.5 Access Control setting ★

Access Control settings are designed for user's Time Period and control unlocks and related parameters of equipment settings.

if Registered users are unable to unlock until he/she comply with the following conditions:

- 1, the current unlock time should be within any effective Time Scope of the User Time period or the user group Time Period;
- 2, where the user must be in unlock group combine (and user also can work with other group unlock combine, but it is unable to unlock until user work with together).

New register user belong to the first group of users by system default, the default the group Time Period is "1", the default unlock combine is the first group, and newly registered users is defaulted as the unlock state (if the user has modify the related setting of the Access Control, the system will change along with users).

Instructions:

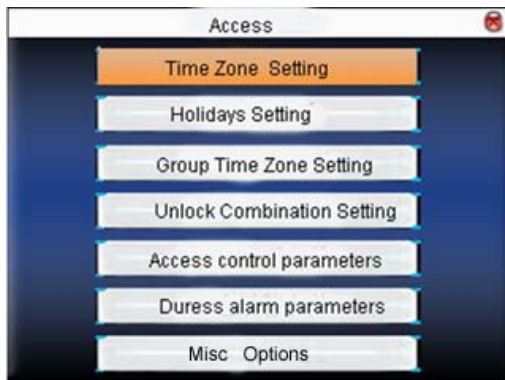

Scroll ▲ / ▼ key to select, press OK button to performance selected item.

2.5.1 Set up Time Period

Time Period is a minimum Time Period unit of Access Control option. The whole system can be defined with maximum 50 Time Period. Each Time Period is the defined as seven hours a week, each Time Period is the effective time in 24 hours a day. Each user can own maximum 3 Time Period, the three Time Period is "or" relationship, as long as the Time Period the certification to meet one of these three Time Period is effective. The time of each Time Period format: HH:MM-HH:MM, in accordance with the 24-hour system that is accurate to the minute.

The end of time is less than starting time (23:57 - 23:56) that represent the day is prohibited, ending time is larger than starting time (00:00 - 23:59) that take effective in this range.

Users unlock the effective time of: opening day (00:00-23:59), or time, the ending time than the beginning of time.

Note: the system's default Time Period is the No. 1 for opening day (that is, newly registered users is permitted to unlock).

Instructions:

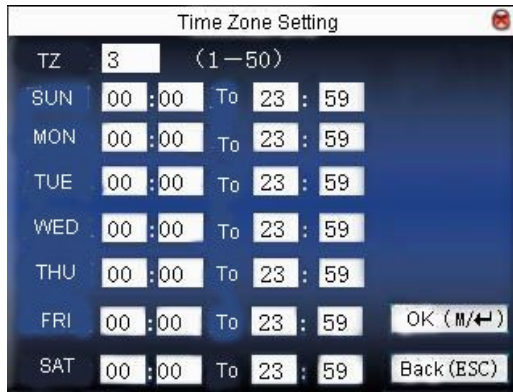

The first entry the number of Time Period, if the No. of Time Period has been existed , then the Time Period setting will automatically refresh and to be displayed. Scroll ▲ / ▼, ◀▶ key to move cursor to the input box, with the small number of keyboard input to the value you want to set, after the completion, press the menu keys to save settings, press the ESC key to exit.

2.5.2 Holidays setting

Introduce the concept of holidays to Access Control. Whenever the holidays is taken, we may need a special Access Control hour, but it is very tedious to change everyone's Access Control hours, it can be used to set up a holiday Access control hour, and this Access control hours is applicable to all staff.

Instructions:

No.	Dates	TZ
01	01.01—01.03	01

Edit OK Menu M/↵

1) additional holidays

Press a menu button, menu operation appear



Scroll ▲ / ▼ button to select new and entered the new interface

New holidays

No.	01		01	M		03	D
Start	01		01			03	D
End	01		01			03	D
TZ	01						

OK (M/↵)
Back (ESC)

Scroll ▲ / ▼, key to move cursor to the input box, with the small

number of keyboard input to the value you want to set, after the completion, press the menu keys to save settings, press the ESC key to exit.

2) Editors holidays

The firstly select the line that want to be edited, directly press **←OK** button or press the menu button, then the operation menu pup-up, choose the Edition:

Edit holidays			
No.	01		
Start	01	M	01 D
End	01	M	03 D
TZ	01		
OK (M/←)		(ESC)	

Scroll **▲ / ▼**, key to move cursor to the input box, with the small number of keyboard input to the value you want to set, after the completion, press the menu keys to save settings, press the ESC key to exit.

3) Delete the holidays

To delete the selected line, press the menu button, the operation menu appear, choose item to be Deleted.

Note: If the Access Control holiday hours has been set, the user in the holidays of a few days open the door that depend on the time set here .

2.5.3 Group of Time Period setting

Group function is divided user into groups, personnel management, the group using the default group staff Time Period, the group is allowed to set the user Time Period. Each group has three Time Period. Newly registered users belong to one group by default, but who can be re-assigned to other various groups.

Instructions:

No.	Default TZ		
01	TZ 001	TZ 002	TZ 003
02	TZ001	TZ002	TZ003

Edit OK Menu M/←

1) Add new group Time Period

Press a menu button, operation menu pop-up



Scroll ▲ / ▼ button to select new and entered the new interface, such as

adding a Group that include Time Period 2 and Time Period 3, as shown below:



Note: 1, when the holidays Setting take effective, the Staff can not open the door; until whose the group Time Period and holidays hours are must be in intersection.

2, when the holidays set to be ineffective, then the team's entry time from holiday.

Scroll ▲ / ▼ key to move the cursor to the items to be set up. If it is the input box, input to provide value with the small number keyboard, If it is a rolling box, scroll ◀/ ▶key to switch and set its value, after complete setting, directly press the menu keys to save setting and return the previous interface, press the "ESC " button to Cancel and return to the previous interface.

2) Editing group Time Period

firstly choose the line to be edited ,directly press ◀ OK button or press the menu button , choose the item to be edited in the event of operation menu appear:



Scroll ▲ / ▼ key to move the cursor to the items to be set up. If it is the input box, with the small number keyboard input to provide value, If it is a rolling box, scroll ◀/ ▶key to switch and set its value, after complete setting, directly press the menu keys to save setting and return the previous interface, press the "ESC " button to Cancel and return to the previous interface.

3) Delete the group Time Period

To delete the selected item, press the menu button, choose “Delete” in the event of the operation menu appear.

2.5.4 Unlock combination setting

Each group will be combined into different unlock combination, so that we can achieve multiple authentication functions and improving the Access Control security. one in the largest unlock combination that can have five groups formed.

Instructions:

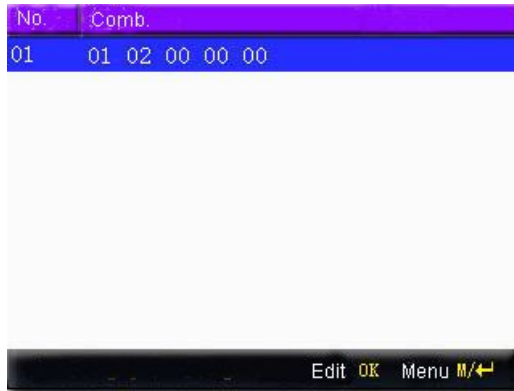

1) new unlock combination

Press a menu button, the operation menu appear.



Scroll ▲ / ▼ key to select new and entered the new interface, such as add a the combination that can unlock in event of which group 1, group 2 together verify successful, as shown below:

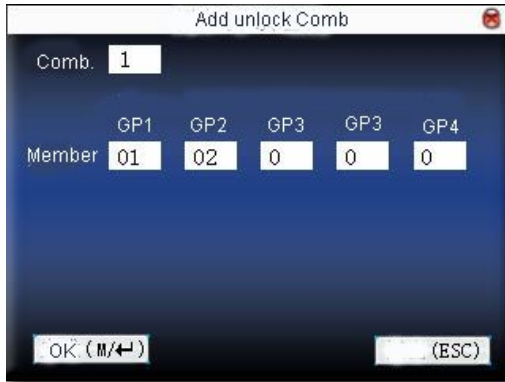

Scroll ▲ / ▼ key to move the cursor to the input box, input the value to be set through the small number keyboard, after the completion, press the menu keys to save settings, Press the ESC key to exit.

2) Editing unlock Combination

The firstly selected item to be edit, directly press the OK button or press the menu button , choose “Edit” in the event of the operation menu appear:

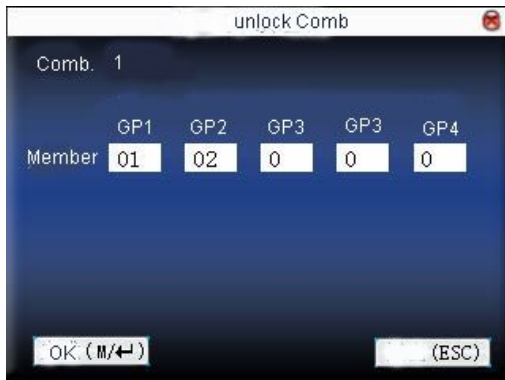

Scroll ▲ / ▼ key to move the cursor to the input box, input the value to

be set through the small number keyboard, after the completion, press the menu keys to save settings, Press the ESC key to exit.

3) Delete unlocks combination

To delete the selected item, press the menu button, choose “Delete” in the event of the operation menu appear.

2.5.5 Access Control Management Parameters

Configure Lock control and related equipment parameters. **Duration of locks driving:** The equipment control performance to unlock after how long time. (RMS 1 ~ 10 seconds)

door sensor delay: the door sensor delay is the duration after the door was opened, How long time to check door sensor after a period of time before detection to open the door, if door sensor state and door sensor switch inconsistent normal began alarm, during this period of time is door sensor delay. (RMS 1 ~ 5 seconds)

door sensor : There are three type: No, normally open, and NC normal closed; None referring to the non-use of door sensor , and normally open the doors opened that is normal, and normally close that door closed is normal state.

Door sensor alarm delay: Do not detect door sensor state at normal state , if over this hours to produce alarm signals, the hour is door sensor alarm delay. (RMS 0 ~ 99 seconds)

Alarm Times by mistake: When the number of identification fail to pass arrived at the number of the wrong values, they have a warning signal. (RMS 0 ~ 9th)

Normal close Time Period : Access Control often set the door to closed during the Period of Time, or any person in this period of time is not able to unlock.

Normally open : set up a regular hours in Access Control system, the lock in this period of time is in the opening state .

The validity of holidays: definition normally open or normally closed at the time of the holidays, set a specific period of time take effect.

Note: 1, if the Time Period of normally open or normally closed has been set, please switch door sensor to no, otherwise it will produce alarm signal during Normal close Time Period or Normal open Time Period .

2, If the normally open or normally closed Time Period is not defined yet the time, the equipment will prompt that you define the Time Period, and transferred to the Time Period interface , to adding.

Instructions:

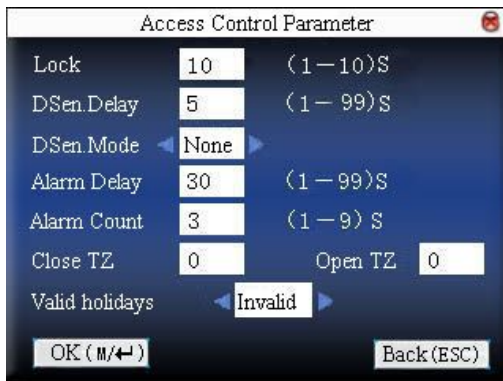

Scroll ▲ / ▼ key to move the cursor to the items to be set up. If it is the input box, input to provide value with the small number keyboard, If it is a rolling box, scroll ◀/ ▶key to switch and set its value, after complete setting, directly press the menu keys to save setting and return the previous interface, press the "ESC " button to Cancel and return to the previous interface.

2.5.6 Duress alarm parameters

Machines also has Duress alarm parameter setting, use newly to enroll specialties fingerprint or define an enrolled fingerprint as the duress fingerprint , the system will trigger an alarm signal when this fingerprint has been authenticate through fair and foul.

Seeking help by Keys: If this item set as "Yes", press hold down PgDn keys (for three seconds and above), produce the recourse signal; press the PgDn keys followed (3 seconds) or input ID or place fingerprint, after the success of identification at the same time a Duress alarm will be triggered , if the keys for help is set to "no", then press and hold down "▼" button, take no role.

1:1 verification methods alarm: If this item is set to "Yes", after users performance 1:1 verification successfully, will produce alarm signals. Otherwise there will be no warning signal.

1: N verification methods alarm: If this item is set to, "Yes", after users performance 1: N verification successfully, will produce alarm signals. otherwise there will be no warning signal.

Password alarm: If item is set to, "Yes", after user go on password verification successfully , will trigger alarm signals, the contrary will not alarm signal.

Alarm duration: after trigger the Duress alarm, Do not directly output signal, but after a period of time that can be defined, then automatically alarm signal (0-255 seconds).

Instructions:

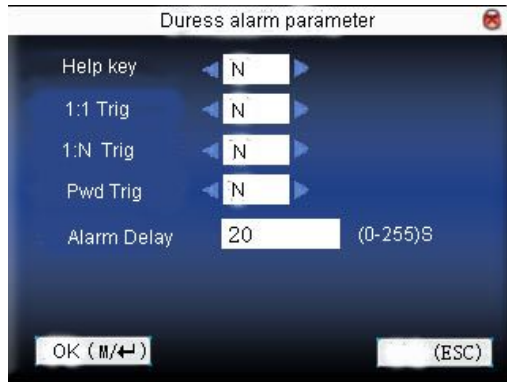

Scroll ▲ / ▼ key to move the cursor to the items to be set up. If the input box by the small number of key keyboard input to provide value If it is a rolling box, according / key switch to set its value, directly installed by the end of the menu keys can be set up and returned to the preservation of the previous interface, Press the "ESC "Cancel to return to the previous set and interface .

2.5.7 Anti-pass back Options★

Configure Anti-pass back function of this device, for more detail , please refer to appendix 6 about anti-pass back function.

2.5.8 Relieve alarm

Equipment is in a state of alarm, press the menu button, the device will be called "whether to relieve alarm?", alarm has been thrill until If you relieve alarm state. After choice is to relieve alarm, the equipment will return to normally state.

The type of alarm equipment: there are door sensor alarm, which detection door was opened without authorization ,anti-dismantle alarm . Duress alarm.

2.6 Card management★

The Mifare Card is contact less smart card ,the working frequency is 13.56 MHz and, can be integrated into our fingerprint biometric verification reader, and can support a variety of verification methods to meet the needs of different groups of people.

Instructions

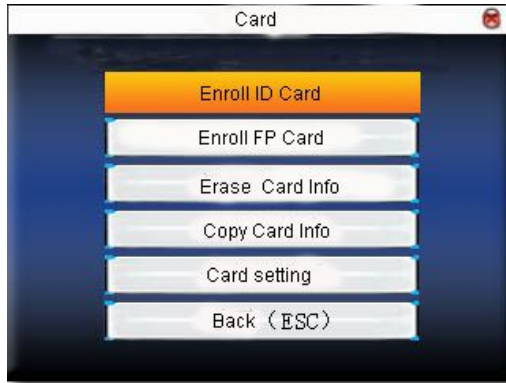

Scroll ▲ / ▼ key to select, press ←OK button to implement selected projects.

2.6.1 Registration number card

Mifare cards maybe used as ID card, registration card number only, and do not register fingerprints.

Instructions

1, registration

Step 1: Select button to register card number, press ←OK to confirm.

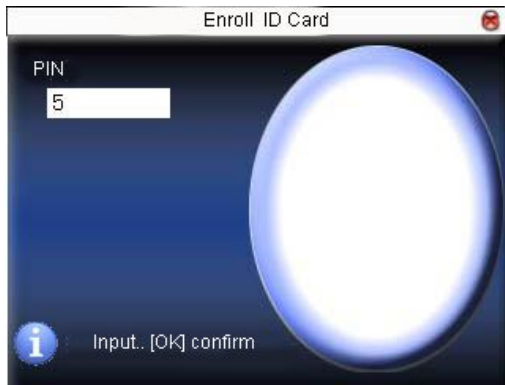

Step 2: Press keyboard to input the registration number (if the number is already existing in the user equipment, the equipment will be prompted to copy the information of card), then press confirmed button

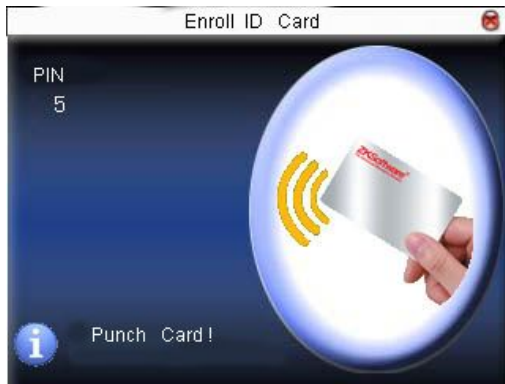

Step 3: The equipment prompt that please show cards.

Step 4: place the cards near the induction zones. the equipment will prompt that register / copy successfully.

2, Verification:

wave the card near induction area, after the equipment find the card, remove the cards from the equipment, after the equipment prompt that verification is completed successfully verified.

Note : Please enter the user Access Control settings and switch to the RF test, or they will not validated.

2.6.2 Registered fingerprint cards

Register fingerprints and write fingerprint into card.

Instructions

1, registration

Step 1: Select button to register fingerprint cards, Press  OK to confirm.

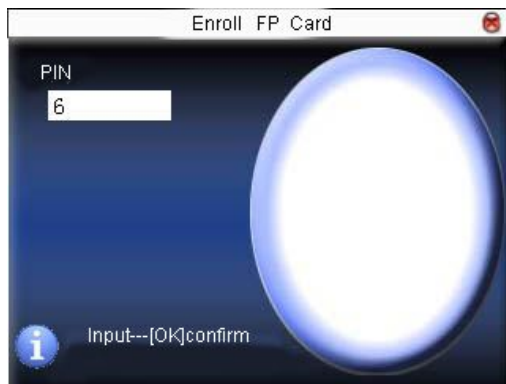

Step 2: Press keyboard to input the registration number (if the number is already existing in the user equipment, the equipment will be prompted to copy the card information, go to step 4) and then press ← OK keys to confirm, equipment will prompt that place finger .

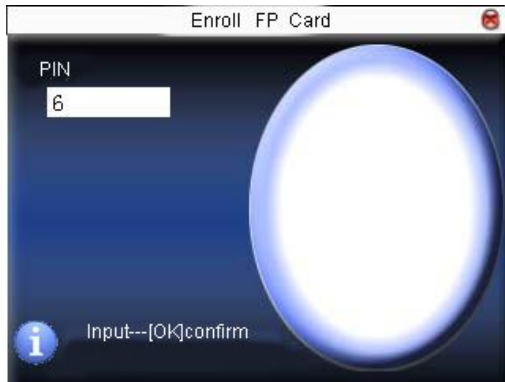

Step 3: correctly press finger three times.

Step 4: equipment will prompt 'Please punch card'.

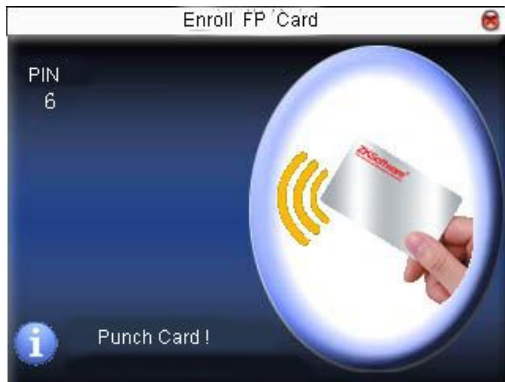

Step 5: place the cards near the induction area, waiting for the equipment read fingerprint data into the card until the equipment motion that the registration is successful.

2, Verification:

Slight ware card the near induction, after the equipment induct the card, to be removed card from equipment , equipment motion to press fingerprint, after successful and completion of verification. If the placed fingerprint and storage of fingerprint cards is inconsistent, it would fail to pass verification.

2.6.3 Clear Card Information

The current operation will delete all the information in the card.

Instructions

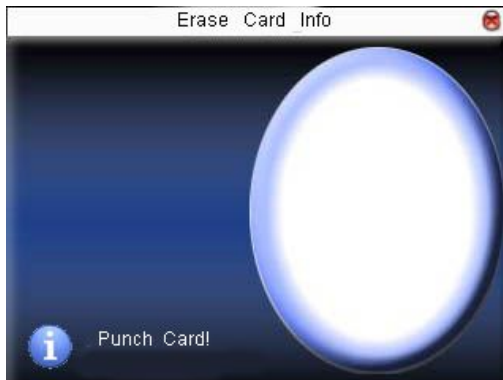

place the cards near area, waiting for all card information will be deleted by the equipment ,if card data still is stored on the devices, the

equipment will also motion whether you want to remove the equipment information, choose "Yes" , the user fingerprints and information in the equipment, choose "no" , then keep up information in the device.

2.6.4 Copy card information

Card information will be copied to the device (after copying fingerprint still exist in the card), after copying, directly track attendance on the equipment by the fingerprinting, without the use of mifare cards.

Instructions



Scroll ▲ / ▼ key to select users, copy the information only, or copy the user information and fingerprints and then press ←OK to confirm

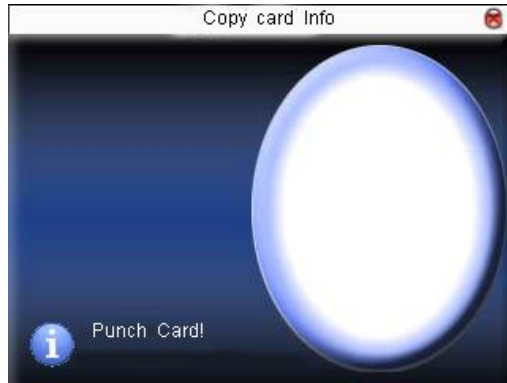

2.6.5 Card parameter setting

Set Mifare card passwords and the save information to the machine.

Fingerprint cards Password: after the password set up, the equipment write the password into fingerprint card which has been registered in the machine, then the fingerprint cards only is used in this machine.

Information must be saved to this machine: When register the numbers card or the fingerprint card, whether will be kept to register the information to the machine. Select item as the "no", the information only store in the card; select as "yes", then the value store in this equipment and card both.

Instructions

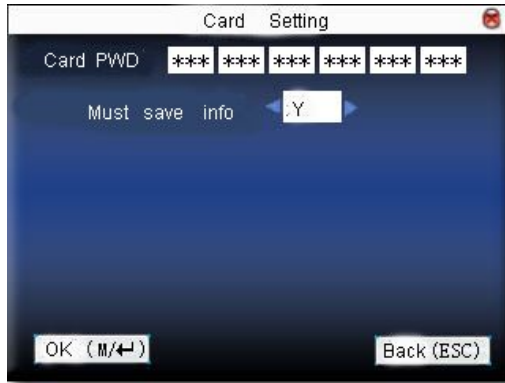

Scroll ▲ / ▼ key to move the cursor to the items to be set up. If it is the input box, input to provide value with the small number keyboard, If it is a rolling box, scroll ◀/ ▶key to switch and set its value, after complete setting, directly press the menu keys to save setting and return the previous interface, press the "ESC " button to Cancel and return to the previous interface.

Note: there induction area is above 3cm—5cm the fingerprint sensor.

3 Communication setting

If when transfer the data between the equipment and PC, it is necessary to set the equipment communication parameter Press the transmission cable, When the equipment and the machine are in the communication, the "in the work... ..“Message will display on the equipment Please did not operate the equipment by now.

Note: please inspect the setting here before the machines communicate

with the computer, the parameter must be consistent with one on the communication option on the software.



3.1 Configure networks

To find sitting on the fingerprint machine if you are using Ethernet communication, following sitting:

Machine IP address: Default IP is 192.168.1.239, you may change, modify it; Do not set IP as same as the IP of PC that the fingerprint machine connect with.

Subnet mask: Default mask 255.255.255.0, you may change, modify it.

Gateway address: the Default gateway address is 0.0.0.0, if the equipment and PC is not in the identical network segment, set up the gateway address firstly.

Network speed: The network run speed, there are three kinds of options, automatic adoption, 10M, the 100M, set up network speed Press your

equipment that is plugged into a local area network using Ethernet cable

Instruction

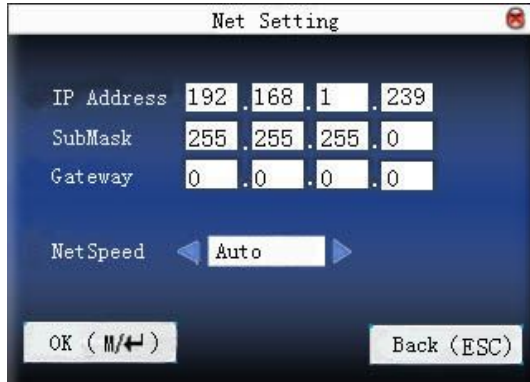

Scroll the ▲/▼、◀▶ key to shift the cursor to input box, configure the value with the numeric keyboard input, when it locate to the network speed, scroll the ◀▶ key to select value which is your favor. After the set up, directly press ↵ OK or the M/↵ key to save the settings and return to unpagged, and return to an interface, press the ESC key to cancel.

3.2 Configure serial port

To find sitting on the fingerprint machine if you are using serial port (RS232/RS485) to communicate between the equipment and PC, configure the following parameter:

Baud rate: the rate at which fingerprint machine communicate with the

PC , there are five kinds of options 9600, 19,200, 38,400, 57,600, 1.15200 bit/sec, the high speed communication is quick, we recommend that high speed apply to the RS232communication ; The low speed communication is stable, it is better the low speed apply to theRS485 communication;

RS232: Whether using RS232 communication or not, if the RS232 will be used, then this choice is "Yes";

RS485: Whether using RS485 communication or not, if the RS485 will be used, then this choice is "Yes".

Instruction



Scroll the ▲/▼key to shift the cursor on the item you need set, scroll the ◀/▶key again to shift the value which you choose. After setting up, directly or then press OK or M/←key to save this setting and return to preceding interface, press the ESC key to cancel.

3.3 Setting up connections

It is necessary to set the serial number before the PC communicates with the fingerprint machine over the RS232/RS485 cable.

Serial number: The serial number of the fingerprint machine, which scope is from 1 to 254, if when using the RS232/RS485 communication, be sure to input this serial number in the software communication interface firstly.

In order to keep up the security of the time & attendance record data, here you may set up the connection password, unless input this connection password in the PC machine software and fingerprint machine is unable to interconnect to read the data when the fingerprint machine connect to PC successfully.

Connection password: The system default password is 0(namely the password does not exist), it is allowed to set it as other values, after setting up, be sure to input this password before the software communicate with the equipment , otherwise you will fail to create connection between the fingerprint machine and PC software. The connection password length is 1 ~ 6.

Instruction

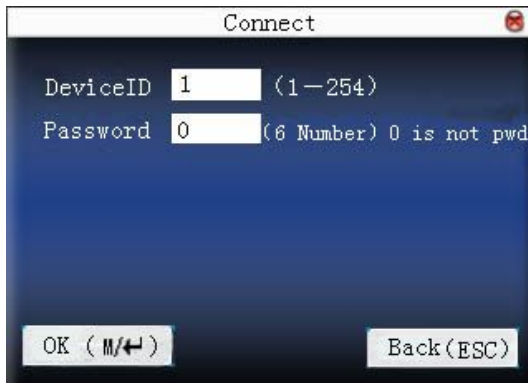

Scroll the▲/▼key shifts the cursor to input box, configure the value with the numeric keyboard input. After the setup completed, directly press OK or the **M/↵** key to save the settings and return to preceding interface, press the ESC key to give up option and return preceding interface.

3.4 WiFi Setting★

Before the equipment apply to wireless Network, another physical component of that 802.11 network consist Distribution system, Access Point, Wireless Medium must exist.

You must know the ESSID (name of network) of local network you want to connect to

wireless Network ID: local wireless Network that you want to connect with (capital letter and small letter is different)

Network model: there are two option , Infrastructure Model, and Ad-

hoc Model; this Infrastructure Model will apply to Hub and Spoke wireless network, the Ad-hoc Model is used in the peer to peer wireless network..

the Authentication Type: The Infrastructure Model include five Authentication Type that are OPEN 、 SHARED、 WEPAUTO、 WPAPSK、 WPA2PS.

the Ad-hoc Model include OPEN 、 SHARED 、 WEPAUTO WPANONE four type of Authentication Type

Encrypt Type: When the item NONE of encrypt Type is selected, then the password in WEP (Wired equivalent privacy) and WPA (WiFi protected access) item is not permitted to modify it, it is not need to input password too.

This PC IP address: If there is the DHCP function in the 802.11 network Distribution system , you may choose DHCP, press OK to exit.

Otherwise, full the IP Address, Subnet Mask blank with the correct figure, press OK to exit to main interface.

Instruction

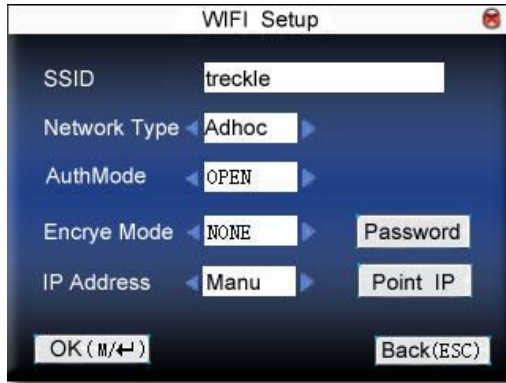

Scroll ▲ / ▼ key to locate the cursor in the inputting box or the button , start the T9 inputting method, type the network identify ID, network identification ID must be correctly enter , otherwise it will be unable to move the cursor to the other input box, through scroll ◀▶ button to select the Items that need to input the other the input box is available, or positioning in the confirmation button and then click the corresponding button to enter the operation.

1) Set a password:

According to the choice of authentication methods and different forms of encryption, password interface are also different. There are two settings WEP and WPA .

WEP password

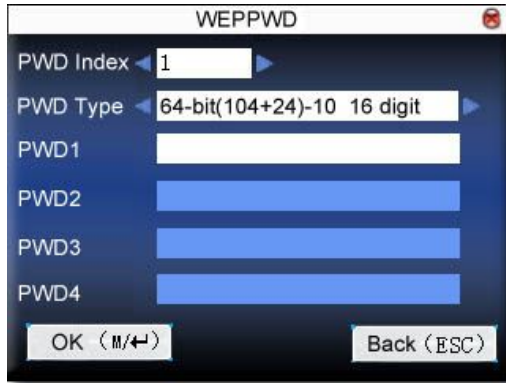

Type the valid password , there are the four groups password in the WEP password, if the four groups have been set to the correct password, only the currently selected password take effect.

WPA password



Enter the valid password , after set a password, Press OK/(M to save your settings and return to wireless setting interface.

2) Assign IP:

Here assign the IP address to the wireless network equipment. Which does not associates with the network settings of communications setting

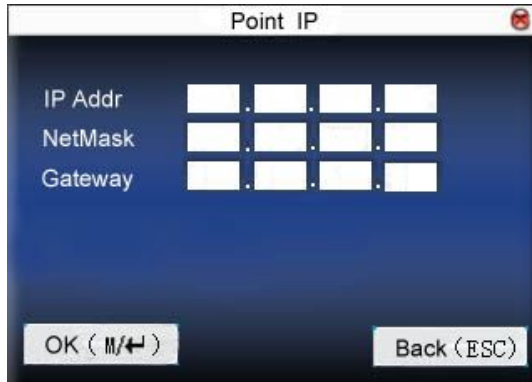

Field	Box 1	Box 2	Box 3	Box 4
IP Addr				
NetMask				
Gateway				

OK (M/←) Back (ESC)



After assigned IP to the device , Press OK to save your settings and return to set up wireless interface.

After all set up by direct press OK to save the settings and return to the previous interface, press the "ESC" to the cancellation and return to set up an interface.

3.5 Wirless LAN★

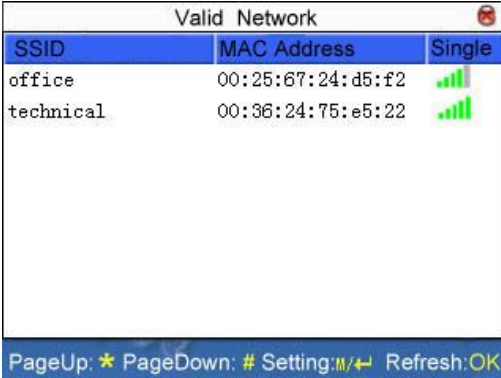
Show equipment in the current environment in which the wireless signal can be received and the strength of signals for users to select the network to provide a better basis.



SSID	MAC Address	Single
office	00:25:67:24:d5:f2	
technical	00:36:24:75:e5:22	

PageUp: * PageDown: # Setting: M/← Refresh: OK

Menu button can be set according to the selected wireless network. ,
refresh the list is available by press OK key

3.6 Wiegand★

The definition of Wiegand input and output format.

Pulse interval: which is default 900 microseconds, can be adjusted between the 200 and 20000.

Output: wiegand output signals contained in the content choose to include workers, or card number.

Instruction

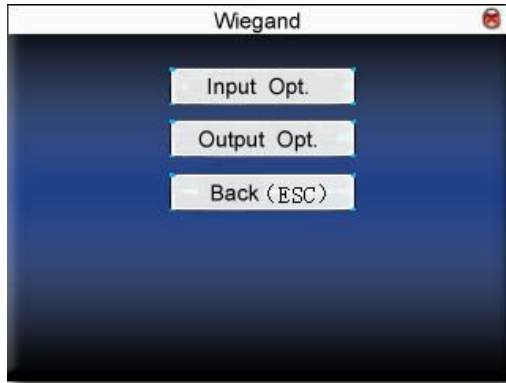

3.6.1 Input Options

User self-definition format: Wiegand input format is defined by the user-self.

Bit: the length of wiegand data bit.

Pulse Width: refers to the Wiegand pulse, width the default is 100 microseconds, can be adjusted within the scope of 20-800 .

Pulse interval: the default 900 microseconds can be adjusted between the 200-20000.

Pulse extent: weight input signal contain the content, which includes choice of PIN, or card number .

Instruction

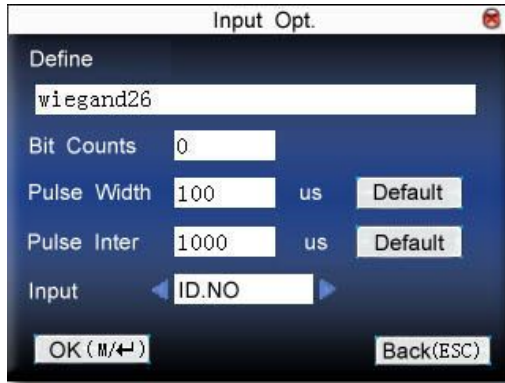

Type the name of self-definition format, scroll ▲ / ▼ key to move the cursor to the item to be set up. If here is the input box, press the number keys to input the value as you want to set, if here is rolling box, scroll ◀▶ key to switch the value, After completed .press OK to save your settings and return preceding interface, press the "ESC" key to cancellation and return to the preceding interface.

3.6.2 Output Options

Format: built-in system format, and it has been defined, users do not need to specify the total length of all information and the location.

4 kind of definition format by the system default: wiegand26 with sitecode, wiegand34 with sitecode, wiegand26 without sitecode, wiegand34 without sitecode. The wiegand26 with sitecode refer to the W26 output format with the equipment No. wiegand26 without sitecode refer to the W26 format output without site code. If there is no set site code, the output signal does not contain the information, if set up a site

code, the output is set a site code (similar to machines No., this is different from the user's own code is designated, and the different machines Can repeat, in the range between 0-255).

Failure ID: verify output after the failure of the failure of ID number, when the choice is not the closure of the output. Range between 0-65534.

Site Code: similar to machines No., this is different from the user's own code is designated, and the different machines can repeat, in the range between 0-255.

Pulse Width: refers to the Wiegand pulse, width the default is 100 microseconds, can be adjusted within the scope of 20-800.

Pulse interval: the default 900 microseconds, can be adjusted between the 200-20000

Pulse content: weight input signal contain the content, that include choice of PIN, or card number

Instructions

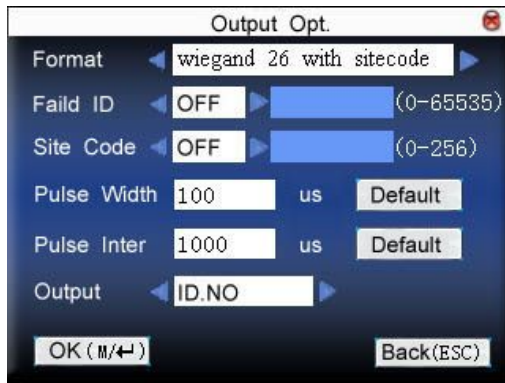

Scroll ▲ / ▼ key to move the cursor to the item to be set up. If it is the input box, type the number keys to input the value, if it is the rolling box, scroll◀/ ▶ key to switch to set the value, for example, attempt revise the failure to type ID figure to 10, scroll◀/▶ key to set the options as open, then enter 10 figure in the box. After completed, press OK to save your settings and return main interface, press the "ESC" key to cancel and return to the main interface.

4 System Setting

To set up system parameter, make the equipment at the function, display with the perfect exhibition, pursue user's satisfactions.



4.1 Systems parameters

1: 1 matching threshold: When use ID+ fingerprint to recognize. Threshold a predefined number , often controlled by a biometric system administrator , which establishes the degree of correlation necessary for a comparison to be deemed a match .if the score resulting from template comparison exceed the threshold , the templates are a “match” (though the template them selves are not identical

1: N matching threshold: the degree of correlation matches with the registration template. Recommend matching threshold setting: e. (effect

value is 1 ~ 60 minutes)

Suggested Threshold Settings

FRR	FAR	One-to-many	One-to-one
High	Low	45	25
Middle	Middle	35	15
Low	High	25	10

Time format: Set up the time format in the fingerprint initial interface.

Scroll ◀▶ key to choose form, the fingerprint machine supports 10 kinds of dates forms, YY-MM-DD, YY/MM/DD, YY.MM.DD, MM-DD-YY, MM/DD/YY, MM.DD.YY, DD-MM-YY, DD/MM/YY, DD.MM.YY, YYYYMMDD, and other date form of your choice

Keyboard voice: Scroll the ◀▶key to determine the whether send a sound when you press key , if set the option as "Yes" ,when press key the machine will utter, if set the option as ("No") you press key the machine doesn't utter.

Voice (Adjvo): Through the ◀▶/ key configure the voice prompt, the equipment can produces the corresponding voice Prompt when the operation.

Volume: Adjust volume. Scroll ◀▶key to adjust volume as your favor

Alarm attendance log(Alms Attlog), When the remainder log capacity reached set numerical value, it will automatically sound warning that logs will be full (virtual value is 1-99).

Recheck Minute: set it within the scope (unit: minute). Someone

attendance has been recorded, then the second record will not display (virtual value is 66)

Instruction

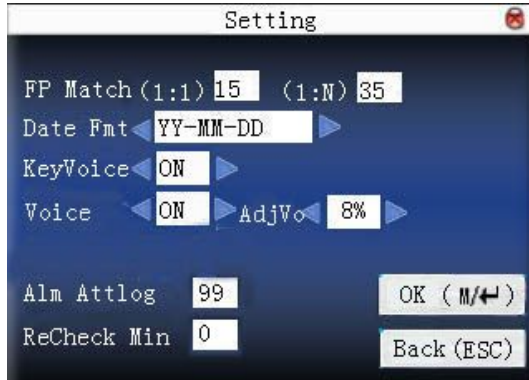

Scroll the▲/▼key to shifts the cursor on the item which you need set. If the item is inputting box, configure the value with the numeric keyboard input; If the item is rolls the frame, Scroll the◀▶ key to choose the value you need, after the setting finished, please directly press OK or M/← key to save this item and return to preceding interface, press the ESC key to give up operation and return to interface.

4.2 Data managements

Delete attendance record (Clear Attlog): Deletes all attendance record.
Delete the complete datum (Clear All): Delete all registrations personnel information, the fingerprint and the attendance record.

Clear Admin Privilege: Change the Administer privilege into ordinary users' option:

Instruction



Scroll the▲/▼ key to shift the cursor on the button which you will operate. press OK or **M/4** to start operation, when the prompt “ Are you sure to continue the current this operation?” appear on the equipment, press OK or **M/4** key again , be sure that the data will be deleted, if after you delete the data, the data will be unable to restore. Press ESC key to exit and return to up aged.

Clear picture: to eliminate the picture by the U flash disk on equipment.
(How to upload picture, please to see 5.4 to upload definition picture)

Instruction

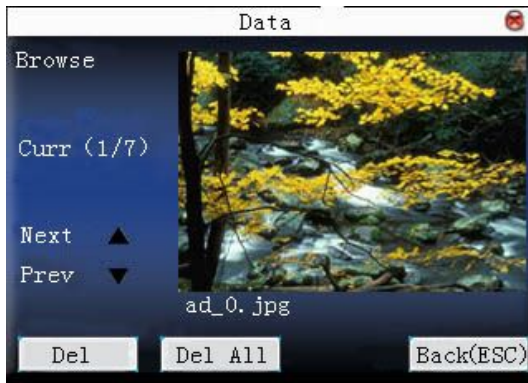

Scroll the "▲/▼" key to preview the advertising picture which has already saved in the equipment, if you want to delete this picture then click on the OK key to delete it, after the prompt to delete successfully appear on the equipment , after deleted completed automatically jumps to the next picture. If you want to delete all advertising picture in the equipment, click **Clear All** button. Press the ESC key to return to the data management interface.

4.3 Upgrade firmware

If want to upgrade the firmware of machine, my use the USB flash disk through this option.

Caution: the user does not random upgrade the firmware, you must be allowed by the dealer before to upgrade the firmware, voluntarily upgrade occur the trouble which possibly affect your normal use

Instruction

Plug the USB flash disk with Upgrade file into slot, click on this item, the equipment will automatically recognize upgrading file and upgrade firmware, the corresponding prompt will appear to show upgrade successfully or fail.

4.4 The definitions of keyboards★

4.4.1 Condition key definition

Customize the attendance condition key on the equipment, after press the corresponding condition key again, the attendance condition of this attendance record is this condition key.

When press any condition key on initial interface left, the attendance condition which correspond the condition key will appear under the screen left, provide user with the convenient to examine.

Instruction

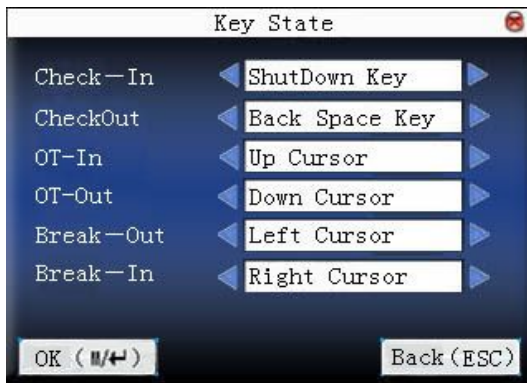

Scroll the ▲/▼ key to shift option box, Scroll◀/▶ key to change the setting. After you complete set up, please press "OK" to save this configuration, press the ESC key to abandon operation and return to the interface.

Note: If some condition keys have no use , then set this condition key as invalid.

4.4.2 Short cut keys definitions

To define the short cut function of each key, it is allowed to define a key as the short cut key for the attendance condition or view function of the shortcut key. When the equipment is in the readiness interface, press the key to display the Time & Attendance condition or fast quickly enter the function interface.

Instruction

Shortcut	Function	Code	Name
F1	Status Key	1	Check-in
F2	Status Key	2	Check-out
F3	Status key	3	OT Check-in
F4	Status key	4	OT Check-out
F5	Status key	5	Out
F6	Status key	6	In
F7	Undefine		
F8	Undefine		

Pageup * Pagedown # Edit 08

the shortcut key definition Scroll ▲/▼ key to browse key line by line.
the shortcut key definition. Scroll PageUp/PageDown key to browse

page by page

press "OK" to key edit the selected shortcut key .

4.4.2.1 set short cut keys

Select a shortcut key, press OK to enter the edition interface.

Function: set this key to the shortcut function. Include the condition key, work code, the short message.

After the condition key is selected the following option appears:

Code: Assigns a code to the condition key, provide user with convenient to view and statistics record .

Name: This key indicates the name of condition.

Automatic switch: When arrives at the appoint time, equipment automatically switch the attendance condition.

1) Set to the function key

Instruction

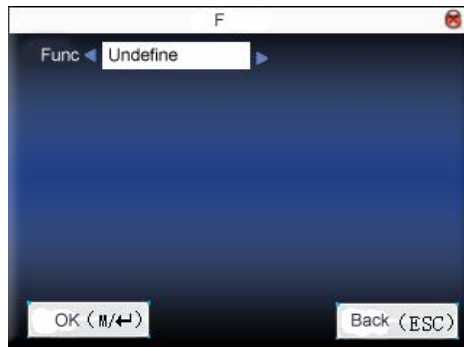

Scroll ◀/▶ key, the "*" key may be defined to work code or the short message, the function definition key.

2) Establishes as the condition key

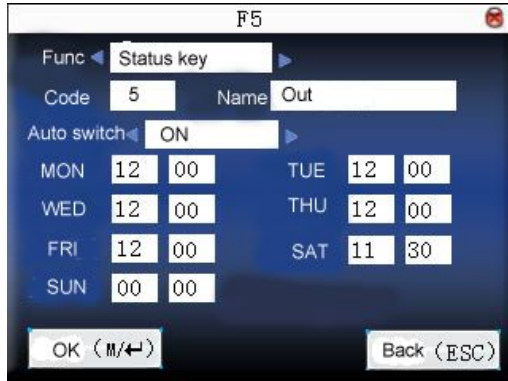

Scroll ▲/▼ the key to switch input box, press the numeric key to input or Scroll ◀/▶ key to set the value. After the setting completed, directly press **Enter** to save and returns to interface, the press "ESC" to cancel setting and return to the interface.

4.4.2.2 Use shortcut keys

1) condition key

press "F3" as the equipment is in readiness window, the corresponding condition icon will appear below left corner of the screen



2) the Function of the shortcut key

For example, set the“ * ”key to work code in the setting option .

Press“*”key to enter the work code choice interface.

4.5 Window Setting

When user go on verification with 1: 1 matching or password, the following situation, to forgot the registered finger or improperly press the finger, possibility to appear, provide user the convenient to reduce the repetition times to press key, after if you fail to confirm the equipment will permits you try again. You also may do yourself favor to set the initial windows.

Clock mode: After the user verifying operation, the clock style of your choice will display on the verification screen here, regardless of the success or failure.

Advertising Picture: The user may place some the advertising pictures display on the screen Press need.

1) The circulation interval of the picture (Picture Loop) refer how long time separately transfer the advertising picture (virtual value is 3 ~ 999 seconds)

2) the time delay refer to how long the clock picture display after the user verification finished, the time delay pass over, the initial window will display the advertising picture again. (Virtual is 0~ 999 seconds, 0 express continuously display clock picture.)

Instruction

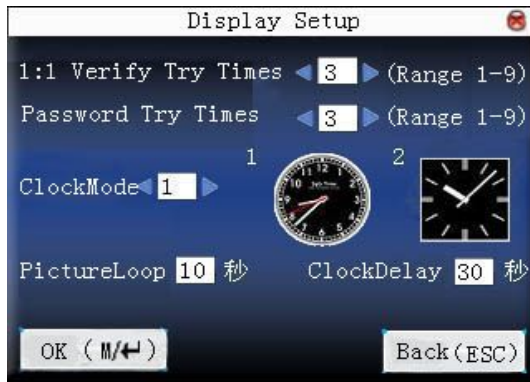

Scroll the▲/▼key shifts the cursor to input box, set up the value with the numeric keyboard input,. After the set up, directly press OK or the **M/↵** key to save the settings and return to preceding interface, press the ESC key cancellation and return to on an interface

4.6 Restore setting

Restore the communications setting, system settings, to the factory settings.

Reset all the default Parameters: the parameters of the machine will be fully restored to factory settings.

Reset the keyboard Parameters: the keyboard corresponding definition set to the factory settings.

Reset Alarm Parameters: the alarm settings call back to the factory settings.

Reset Other Parameters: communications settings, system parameters, such as the interface settings call back to the factory settings.

Reset Access Parameters: access control settings and user access control settings back to the factory settings

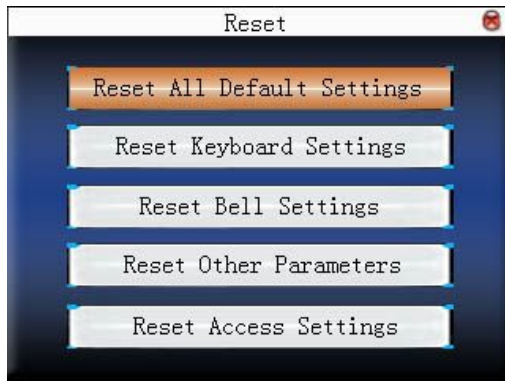

Scroll ▲ / ▼ key to select, press OK button to restore the settings.

Note: when Restores the setting cannot erase the personnel information and the attendance record in the equipment

4.7 Bell setting★

It is popular to ring in many companies when the people should be work, but there are two the tradition way to ring with the man-power or the special electron. In order to get economy and convenience management, we will integrate the time bell function in the fingerprint machine, you will be allowed to schedule bell depend on actual need, at appoint time, the fingerprint machine will automatically broadcast bell sound that you are choice, when after duration of the bell, the bell will automatically stop.

Instruction

Bell	Bell Time	Ring	State
Bell 1	08: 00	Bell101. wav	
Bell 2	00: 00	Bell101. wav	
Bell 3	00: 00	Bell101. wav	
Bell 4	00: 00	Bell101. wav	
Bell 5	00: 00	Bell101. wav	
Bell6	00: 00	Bell101. wav	
Bell7	00: 00	Bell101. wav	
Bell8	00: 00	Bell101. wav	

Pageup ▲ Pagedown ▼ Edit OK Menu B/4-1

Scroll ▲/▼ key to view the bell setting in line by line.

Scroll PageUp/PageDown key to view the bell setting in page by page.
 Press "M/↵" key to begin/end the selected bell.
 Press "OK" to set the bell that is your choice, and enter the edition bell.
 Bell time: Arrive at this time the equipment will automatically ring bell.
 Sound choice: bell sound at scheduled time.
 Volumes adjust: Bell sound volume.
 Number of times: When ring bell, how many times the bell ring.
 Bell condition: Whether or not start this bell.

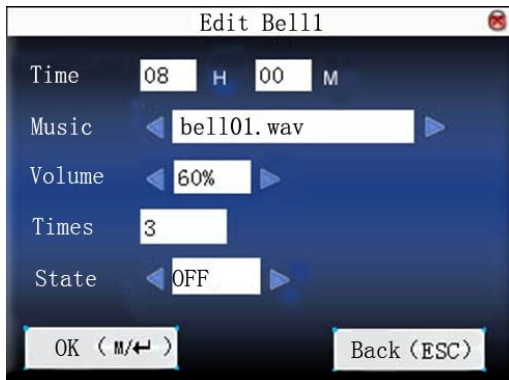

Scroll the▲/▼key shifts the cursor to input box, set up the value with the numeric keyboard input,. After the set up, directly press OK or the M/↵ key to save the settings and return to preceding interface, press the ESC key to give up.

4.8 Misc Setting

Set Sleep time, external ring and other parameters for device.

Sleep time: When the device reaches the set timed dormancy under the

state of not being operated, it will enter dormant state. Press any key or finger to wake up the device.

External ring: select whether to open external ring or not. (External ring means the alarm ring is not uttered by the machine itself, but by the external bell connected with the internal of the machine.)

FP Image: means whether display the fingerprint image on the screen while registration or verification is being done. There are 4 choices: display the fingerprint both at registration and verification, display the fingerprint at registration, display at verification, and no display at registration and verification.

Power Button: Locked shut-down key, to prevent malicious on-off, you can select whether to lock the shut-down key or not.

If you select “off”, the machine will be shut down in 3 seconds after you press the shut-down key.

If you select “on”, pressing the shut-down key will be of no effect.



- Notice: 1. The external ring function requires hardware support. If necessary, please contact the business represent or technical support personnel.
2. Only the machine with shut-down key possesses locked shut-down key.

Instruction



Scroll the▲/▼key shifts the cursor to input box, set up the value with the numeric keyboard input,. After the set up, directly press OK or the  key to save the settings and return to preceding interface, press the ESC key to give up

5 Time date

5.1 Time and Date settings

It is necessary to set the accurate date and time for each of equipments.
To obtain guarantee for tracking accurate attendance time.

Enter option to set the time and date :

Instruction

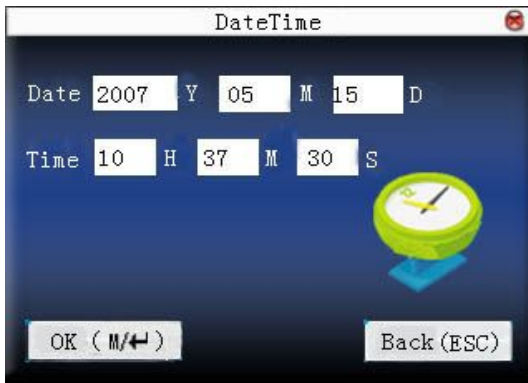

Scroll the ◀/▶ key to switch option input box, Scroll▲/▼key to shifts the cursor input box . set up the value with the numeric keyboard input
After you set up completed, please press "OK" to save this configuration, press the ESC key to abandon operation and return to the up page

5.2 Daylight Saving Time

Daylight Saving Time, also known as "daylight saving time system" is a man-made the local time for saving energy, during the system is used this unity time known as "daylight saving time." Usually in the early morning of the summer people will be one hour ahead of time, people can get up early and early sleep to save lighting to make full use of resources illumination, save electricity. at autumn fall Then call back one hour. The different countries have different specific requirements of daylight saving time.

In order to meet the needs of daylight saving time, we can offer a special custom features, in XX, XX, XX, XX hours, fast one hour, and by the XX, XX, XX-XX, then slow one hour .

Note: Daylight Saving Time function only provide by certain models.

Instruction

When the device have this functional, in the time period interface there will be set up options:

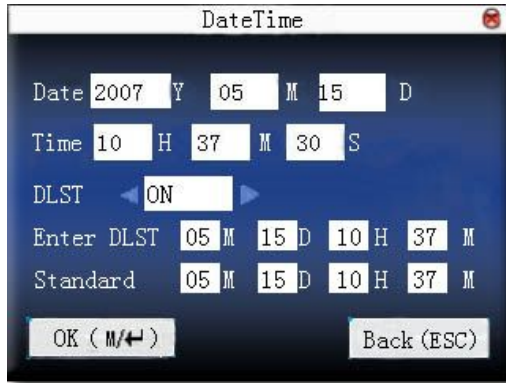

- 1) Set Daylight Saving Time option as "NO."
- 2) Assign Daylight Saving Time start and end times.

For example, setup at 8:00 on April 1, the machines come in the Daylight Saving Time, the counting time will be ahead for one hour. To at 8:00 on October 1, equipment returned to normal time.

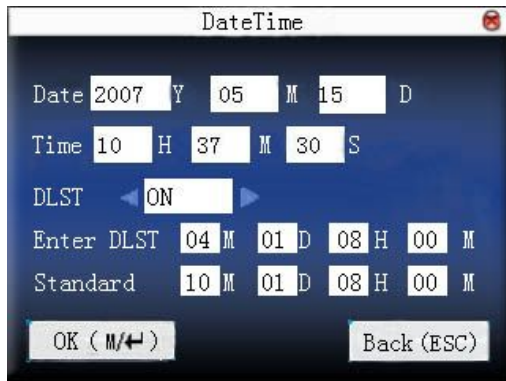

- 3) press **M/↵** "OK" to save the settings; press the "ESC" does not save and exit.

6 USB Flash disk management

Through the USB flash disk, import the user's information, the fingerprint template, the attendance data into and the Time & Attendance tracking software for processing, transfer the user's information and the fingerprint template to other fingerprint equipment.

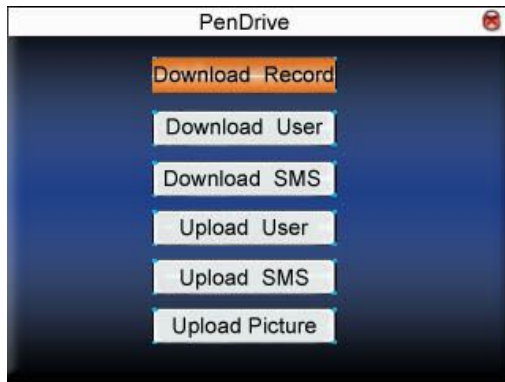

6.1 Download attendance datum

Save all attendance data in the equipment into the USB flash disk.

Instruction

- 1) Plug the USB flash disk into the USB slot of the fingerprint machine through the miniature USB cable.
- 2) Press “▲” and “▼” to scroll up or down the screen to select the

“Download Attlog”,

3) Press “ok” to go on downloading data, the equipment prompt "is downloading the data, please waits... .." until the equipment prompt “download attendance data successful" after operation finishes this interface show as follow.

4) Press “ESC” key to exit initial interface, Take out U flash disk, The files X_attlog.dat (attendance log), X_oplog .dat (management log), and X_user will be saved in the USB flash disk(X is a symbol of machine No.

6.2 Download user’s data

Save all user information and the fingerprint in the equipment in the USB flash disk.

Instruction

Operation is similar with the attendance data.

Plug the USB flash disk into the USB slot of the fingerprint machine, Scroll the "▲/▼" key to choose user data you want to download, if download successfully , the files user.dat (user information) and template.dat (fingerprint template) will be viewed available

6.3 Download SMS★

The short message in the equipment will be saved to U flash disk.

Instruction

Plug the u flash disk into the USB slot of fingerprints machines, through the scroll "▲ / ▼" key to select download short message, after the download successfully, udata.dat and sms.dat 2 files will be find in the U flash disk .

6.4 Upload the user data

Upload the user information and the fingerprint which have been saved in the USB flash disk into the equipment.

Instruction

Plug the USB flash disk into the USB slot of the fingerprint machine, scroll the "▲/▼" key to choose the user data that you want upload, then press the OK key, the two files user.dat (user information) and template.dat (fingerprint template) will be uploaded to the machine . If there are not two files in the USB flash disk, the prompt "copy file" will appear

6.5 Upload SMS★

The short message in the U flash disk U will be uploading to equipment.

instruction

plug the U flash disk into the USB slot of fingerprints machines, then the scroll "▲ / ▼" key to select users to upload data, after choose ,then press OK , the udata.dat and sms.dat 2 files in the U flash disk will be uploaded to the machines.

6.6 Upload the customized picture

Upload the file with JPG picture format which front name include "ad_" in the USB flash disk into the equipment, after these pictures have been transfer to the equipment, it will display in the initial window. (Picture specification, please see appendix 4)

Instruction

Plug the USB flash disk in the USB slot of the fingerprint machine, scroll the "▲/▼" key to preview the picture in the USB flash disk then press the OK key to choose the picture you want to upload ,after if the prompt "upload successfully" display on the equipment , the file will

automatically jumps to the next picture. To upload, after upload picture completed, presses the ESC key to exit.

7. Automatically test

The equipment provides with the automatic test function to test each module in the fingerprint machine, help the operator fast check the module, if the machine breakdown possibly occur. Including TFT screen, voice prompt, clock, keyboard, and fingerprint sensor test. Choose the option to test.

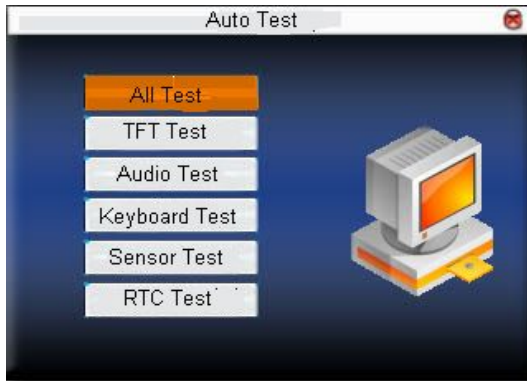

Scroll the ▲/▼ key to select the project that want to be test, press the "OK" key to start

7.1 Test TFT screen



Equipment provide auto-test to check the TFT screen demonstration effect, through when the screen display in color, entire white, entire black, you can inspect each place of the screen at this time , whether the TFT screen demonstrates normally.

Press "OK" to continue to test while the test process, press ESC key to exit from this test.

7.2 Test pronunciations

The equipment offer auto-test voice prompt effect, through play voice file in the equipment, check whether the voice file is completed, and the pronunciation effect is in good. Press "OK" to continue to play voice while the test process, press ESC key to exit from this test

7.3 Test keyboards

The equipment carries on the automatic detection to each keyboard, tests each key of keyboard is normal. In the keyboard test window, stochastically press any key of the keyboard (except the "OK" and "ESC" key), check whether the key of the keyboard you press accord with the display on the screen. The key you press display in garnet  color, otherwise the key  in gray black. Press "ESC" key to exit from this test

7.4 Test fingerprint Sensor

The auto-test fingerprint sensor told user whether the sensor is in normal, through the test you can examine the picture resolution of the fingerprint, whether the fingerprint picture is clear, and the screen will real-time show fingerprint picture that capture from the finger when you place the fingerprint sensor window. Press ESC key to exit from this test.

7.5 Real-time clocks

The equipment provides function to test the clock, through to stopwatch test you will get result about whether the clock is in normal operation or not.

Press the OK key to start to time, press the OK key again to stop time, check whether the equipment times are in accurately. Press ESC key to exit from this test.

8. Inquiry record

When the fingerprint machine track the staff time & attendance successfully the record will be saved in, in order to provide the staff with convenience to know his/her attendance logs, this machine offer the inquiry record function.

8.1 Inquiry attendance

Depending on the inquiry condition that the user defines, the record that conforms to the inquiry condition will display on the screen, it is easily user to view.

Enter the inquiry menu, first input the condition in the blank. Then input personnel's serial number and the date scope that you want to inquire



The screenshot shows a window titled "Attlog" with a dark blue background. It contains the following fields and controls:

- AC.NO: A text input field containing the word "All".
- Start: A date and time selection area with dropdown menus for "05", "Mon", "15", "Day", "0", and "Hour".
- End: A date and time selection area with dropdown menus for "05", "Mon", "15", "Day", "24", and "Hour".
- A magnifying glass icon is positioned to the right of the date fields.
- At the bottom, there are two buttons: "Ok (M/↵)" and "Back (ESC)".

1) When the AC.NO that you input is empty, express that all staffs will

be inquired

2) Input some AC.NO, then inquiry this staff's attendance record only. After complete to inquiry these records which meet the inquiry condition will appear on the screen:

Date	AC.NO	Attlog
05/07		Total Record: 10
	1	07:20 12:03 13:28 18:02 18:59 21:14
	2	07:25 12:24 13:30 18:10
	10001	07:54 12:05 13:31 18:24
05/08	1	07:35 12:22 13:22 18:04 18:04
	2	07:42 11:59 13:24 18:12
	10001	07:21 12:14 13:12 18:30
	10002	07:45 13:25 18:00
05/09	1	07:55 08:56 08:56 08:56 08:56 08:57
		08:57 11:20 12:25 13:21 19:00

PageUp : * PageDown : # Detail Rec : M/←

Scroll the ▲/▼key to locate the cursor to the line that you want to view, press OK key to browse the detailed Time & Attendance log.

For example on May 8 10001 staffs' detailed situations:

AC. NO	Name	ATT	Verify	State
1		05/07 07:20	F	1
1		05/07 12:03	F	0
1		05/07 13:28	F	2
1		05/07 18:02	F	3
1		05/07 18:59	F	6
1		05/07 21:14	F	7

Record Num. : 6 F : FP S : CheckIn

The information of the note display underneath the screen, namely various letters meaning.

Verification

F: Express the fingerprint verification.

P: Express the password verification.

State

The number is the code of state.

9. Systems information

Through the system information option, you may know this machine memory as well as the machine edition information and so on.

9.1 Logs capacity

Through the log capacity you can know the number of users, managers, registration password in this machine; as well as the machine fingerprint capacity and the registered fingerprint, the attendance logs capacity and the memory attendance logs capacity are respectively demonstrated by the graphic mode, shown as following graphical

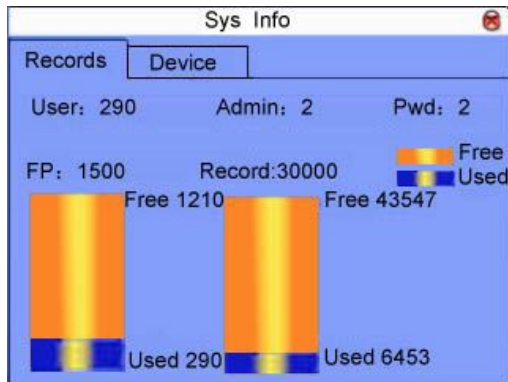

9.2 Equipment information

In the equipment information the machine equipment name, serial number, version information is available.

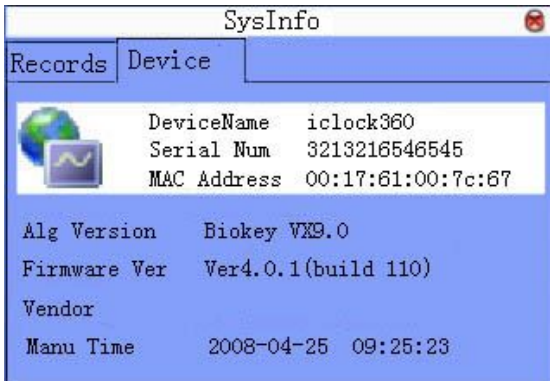

Appendix 1 Getting familiar with keyboard





The equipment keyboard meets with the different function in different interface, for detail please see the next table.



One model:

key	detailed solution
numeric keyboard	1, 0 ~ 9, is used in to input the staff to number, numeral and password so on. 2、 in the management user interface digital 0 are " search user" shortcut key.
▲	1、 Upward . 2、 shortcut key.
▼	1、 Downward . 2、 Shortcut key.
▶	1、 Revision goal value. 2、 Shortcut key
◀	1、 Revision current project 2、 Shortcut key
Ⓞ	1、Shut down key. Press this key least for 3 seconds in the initial interface to enter the shut down machine state. 2、 Shortcut key
←	1、 The backspaces key. If when input AC.NO, password, system setting value ,if you make the mistake , press this key to be possible to delete the value ,input it again.



	2、Shortcut key.
	menu key, confirms the ESC key
ESC	1、 Cancel operation and return to the preceding menus 2、 Press the ESC key to close T9 input method
*	1. in the list window , it is used to page up key 2.shortcut key 3.start the T9 input method
#	1. In the list window, it is used to turn over page key. 2. shortcut key





Two model:

keys	Detail Explanation
Number keys	1,0 ~ 9, is used to input staff numbers, passwords, and other figures. 2, In the user management interface the digital 0 button is used as "View users" shortcuts.
	1, upward . 2, shortcuts.
	1, down 2, shortcuts.
	1, modify the value of the current project. 2, shortcuts.
	1, modify the value of the current project. 2, can be used as shortcuts.
	1, shutdown button. In the initial interface, hold down this key for three seconds into the shutdown countdown state. 2, shortcuts.

	1, the Backspace key. If when input AC.NO, password, system setting value ,if you make the mistake , press this key to be possible to delete the value ,input it again. 2, can be used as shortcuts.
	Menu Key, confirmed Key
OK	OK Key
ESC	1, cancel operations and return to the previous menu. 2 Press the ESC key to close T9 input method.
*	1. in the list window , it is used to page up key 2.shortcut key 3.start the T9 input method
#	1、 1, the listing pages can be used to turn the pages bond. 2, can be used as shortcuts.

iClock Access Control Series :

keys	Detail Explanation
Number keys	1,0 ~ 9, is used to input staff numbers, passwords, and other figures. 2、 In the user management interface the digital 0 button is used as "View users" shortcuts.
	1, upward . 2, shortcuts.
	1, down 2, shortcuts.
	1, modify the value of the current project.

	2, shortcuts.
	1, modify the value of the current project. 2, shortcuts.
	1、 Door Bell key 2, shortcuts.
	1, the Backspace key. If when input AC.NO, password, system setting value ,if you make the mistake , press this key to be possible to delete the value ,input it again. 2, can be used as shortcuts.
	Menu Key, confirmed Key
OK	OK Select characters
ESC	1, cancel operations and return to the previous menu. 2, Press the ESC key to close T9 input method.
Tab	1, Start T9 input method. 2, can be used as shortcuts.
PgUp	
PgUp	3. In the list window, it is used to turn over page key. 1、 shortcut key.
	1、 in the T9 input method. the Backspace key 2、 can be used as shortcuts.

keys	Detailed Explanation
Number keys	1,0 ~ 9, is used to input staff numbers, passwords, and other figures. 2、 In the user management interface the digital 0 button is used as "View users" shortcuts.

▲	1, upward to switch options . 2, shortcuts.
▼	1, downward to switch options 2, shortcuts.
▶	1, modify the value of the current project. 2, shortcuts.
◀	1, modify the value of the current project. 2, shortcuts.
	Doorbell button
M/OK	Menu, Enter button
ESC	cancel and return to preceding menu

Appendix 2 T9 input method★

The name of T9 input method is the smart input method; it is famous for highly effective and quickly inputting the character, this equipment fully supports the T9 Chinese, the T9 English, and the symbol input. There are three or four English letters on 0 ~ 9 numeric keyboards of the machine, for example the numeric keyboard 1 has the A, B, the C three letters, only input key where this letter locate for the T9 Chinese , Press the algorithm of the program will automatically combine the legitimate Pinyin. Then press the numeric key to choose Pinyin for inputting the Chinese character. The T9 English also comply with the letter arrangement of English word to input, only press key which inputs this letter, the program automatically display this key expressed all letters, press the numeric key to select letter. The T9 input method also may input some marks. May input the name, the short message content through the T9 input method user is able to input the name, the short message content.

T9 input method key distribution and its function:

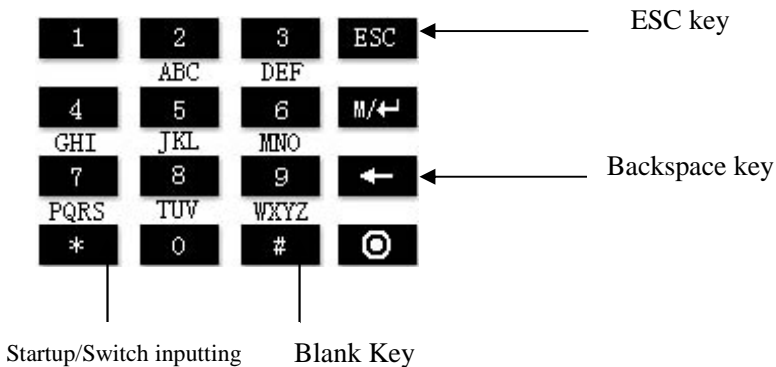



◀/▶: Page up/Down

OK: Choose letter

Take an example for the T9 English input: Input "Arabia " press the * numeric key to enter the T9 input method.



Press numeric 2 key



Pres numeric key to select



Input the letter you select.

If must continue, presses the above method to carry on the input again.
After the input completed, presses the ESC key to exit

Appendix 3 Multi-combination Authentication Mode ★

In order to meet the high-security Access Control occasions needs. Taking into account the use of Access Control, we provide a various functional verification methods, individuals or groups can be set up against a variety of types of verification, there are four matching way types main number (PIN), fingerprints (FP), password (PW) and RF, not only can achieve alone fingerprint, a separate password, ID, and fingerprint verification, could also achieve fingerprint + password, password + fingerprint+ card, numbers + fingerprint + password combination verification methods.

Note: 1) Mifare in specific processing can be regarded as RF,if the verification involved in the type of Mifare card, only use the function of machines Mifare cards may.

2) Except certain specific types of machines, other machines only fingerprint verification and password verification test two types, machines with Mifare card functions, also Mifare card verification. provided

"/" Or , "&" and ,"←" confirmed, (Enter).

The following table describes that the user is registered by fingerprint cards and a password; the following verification maybe is used in future multi- combination verification:

Type	Description
FP	only FP fingerprint verification 1) PIN + FP (1:1 verification) 2) FP (1: N verification) 3) RF + FP (1:1 verification)
PIN	only PIN numbers verification 1) PIN+“←”
PW	only password verification 1) PIN+“←”+PW 2) RF+PW
RF	only RF Card Verification 1) RF+FP
FP/PW	FP / PW fingerprint or password verification 1) PIN+FP(1:1) 2) FP(1:N) 3) PIN+“←”+PW 4) RF+PW
FP/RF	fingerprinting or RF verification 1) PIN+FP(1:1) 2) FP(1:N) 3) RF+FP
PW/RF	password or RF verification 1) RF+FP 2) PIN+“←”+PW
FP/PW/RF	fingerprint or password or RF verification 1) PIN+FP(1:1) 2) FP(1:N) 3) PIN+PW

	4) RF+FP
FP&PIN	PIN number and fingerprint verification 1) PIN+“←”+FP(1:1) 1) RF +“←”+FP(1:1)
FP&PW	fingerprint and password verification 1) FP(1:N)+PW+“←” 2) PIN+FP(1:1)+PW+“←” 3) RF+PW +“←”+ FP(1:1)
FP&RF	RF and fingerprint verification 1) RF+FP(1:1) 2) FP(1:N)+RF 3) PIN+FP(1:1)+RF
PW&RF	passwords and RF verification 1) RF+PW 2) PIN+“←”+PW+RF
FP&PW&RF	fingerprinting, passwords and RF Verification
	1) FP(1:N)+PW+RF 2) PIN+FP(1:1)+PW+RF 3) RF+ PW+ FP(1:1)
FP&PIN&PW	fingerprints numbers and passwords
	1) PIN+“←”+PW+FP(1:1) 2) RF+“←”+PW+“←”+FP(1:1)
FP&RF/PIN	fingerprint and RF Verification or fingerprinting and numbers verification
	1) RF+FP(1:1) 2) FP(1:N)+RF 3) PIN+“←”+FP(1:1)

When enroll user, registered fingerprint card or a password and the number cards, the validation process are shown as the following table:

Type	Description	
	Registration password	Registration fingerprint
FP	only fingerprint verification	
	1) PIN+FP(1:1 verification) 2) FP (1: N verification) 3) RF+FP(1:1)	Failed to pass
PIN	verification numbers only	
	1) PIN+“←”	1) PIN+“←”
PW	only password verification	
	Password wrong	1) PIN+“←”+PW 2) RF+PW
RF	only RF Card Verification	
	1) RF+FP	1) RF
FP/PW	fingerprint or password verification	
	1) PIN+FP(1:1) 2) FP(1:N) 3) PIN+“←”+ FP(1:1) 4) RF+FP(1:1)	1) PIN+“←”+PW 2) RF+PW
FP/RF	fingerprinting or RF verification	

	<ul style="list-style-type: none"> 1) PIN+FP(1:1) 2) FP(1:N) 3) RF+FP 	1) RF
PW/RF	password or RF verification	
	<ul style="list-style-type: none"> 1) RF 2) PIN+“←”+RF 	<ul style="list-style-type: none"> 1) PIN+”←”+PW 2) RF
FP/PW/RF	fingerprint or password or RF verification	
	<ul style="list-style-type: none"> 1) PIN+FP(1:1) 2) FP(1:N) 3) PIN+“←”+FP(1:1) 4) RF+FP 	<ul style="list-style-type: none"> 1) PIN+”←”+PW 2) RF
FP&PIN	PIN number and fingerprint verification	
	<ul style="list-style-type: none"> 1) PIN+“←”+FP(1:1) 2) RF+ PIN+“←”+FP(1:1) 	Failed to pass
FP&PW	fingerprint and password verification	
	Failed to pass	Failed to pass
FP&RF	RF and fingerprint verification	
	<ul style="list-style-type: none"> 1) RF+FP(1:1) 2) FP(1:N)+RF 3) PIN+FP(1:1)+RF 	Failed to pass
PW&RF	passwords and RF verification	

	Failed to pass	1) RF+PW 2) PIN+“←”+PW+RF
FP&PW&RF	fingerprinting, passwords and RF Verification	
	Failed to pass	Failed to pass
FP&PIN&PW	fingerprints, PIN numbers and passwords	
	Failed to pass	Failed to pass
FP&RF/PIN	fingerprint and RF or the fingerprinting and PIN	
	1) RF+FP(1:1) 2) FP(1:N)+RF 3) PIN+“←”+FP(1:1)	Failed to pass

Note: 1) When users register a number of cards and the fingerprint in the equipment at the same time, on the table in the RF test only punch the card, no need then fingerprints.

2) Multi -combination verification methods, it is better to register users use by fingerprints and passwords, or otherwise never pass verification.

Example: A user using a fingerprint registration and the verification is PW way, the user fail to pass.

Appendix 4 Quickly inquiry the staff attendance logs

In order to help ordinary user to view his/her Time & Attendance record at same day, whether forget clock-in or occur error, should well inform the manager that the attendance record is in abnormal

Instruction

After the user verify fingerprint or the password successfully in 10 seconds, the pressed **M/←** key to be bale to show this staff all records in same day.

For example: the staff, who's AC.NO is 1, match the fingerprint successfully, then the press **M/←** key, you will be able to view his /her Time & Attendance record same day.

Date	Attlog AC.NO:					
05/07	07:20	07:20	07:20	07:20	07:20	07:20
	07:21	07:21	07:21			

PageUP: * PageDown: # Detail Rec M/←

Scroll the ▲/▼ key to browse the Time & Attendance record line by line

Press PageUp/PageDown key page by page to browse the Time & attendance record;

Press OK or  key inquiry detailed.

Press ESC key to return the initial interface.

Appendix 5 The rule about the advertising pictures

1. The format of the pictures must be the JPG , the fingerprint machine do not support other format all
- 2.The header of advertising pictures filename must be " ad_0 ~ad_10" as head. For instance ad_1.jpg is legitimate.
3. Each picture size does not surpass over 50K, otherwise unable to upload it.
4. Pictures resolution are 320 widths and 210 high, it is better to surpass or smaller than this resolution.
5. Do not more than 10 sheet of advertising pictures in the fingerprint machine.

Appendix 6 anti-pass back function ★

[Summarize]

If you want to prevent following occasion occur, a people follow the others to enter the building, but he/she do not go out with people together, and potential safety problems arise, this anti-pass back feature provide that, unless the access records match, the door is unable to be open.

This feature requires two machines work with together. A machine is installed in the building (the "host"), other machine is installed in the outside (hereinafter referred to as "client"). Between the two machines connect through Wiegand communications signals.

[Principle]

The host own Wiegand In, the client with Wiegand Out function. Connect Wiegand Out signal of the client machine to the Wiegand In of host machine, Wiegand signal that output from the client machine ,send it to host, must be without machine No., the number in the host must exist, that is the function of two anti-pass back the machines of users And the host must match.

[Instruction]

According to the most recent user accessed records to determine whether anti-pass back, accessed logs must be matching. There are IN ,Out , In-Out to anti-pass back function.

When the host is set to "Out anti-pass back," If a user want to normally access or out, then the last record of the user must be "income" , otherwise it is allowed to go out., system will be "anti-pass back to refuse going out." For example: a user's most recent recording is "in", the second is record his income. The record must be the third to second, is out of matching, and so on. (Note, if there is no record of prior customers, and that he can to, not out)

When the host is set to "In anti-pass back," If a user want to normally access or out , then the last record of user must be "to" can not be out. As long as it is to find the records system will be "anti-pass back refused." (Note, if there is no record of prior customers, he can produce and can not)

When the host is set to "access to anti-pass back," If a user access to normal, then the user is the most recent record "to" and "income", the next record is to be "into" and "out", access must be matching.

[Instruction]

1) the choice of models

Host: the machine with wiegand in function . Except F10

Client the machine: the machine with Wiegand Out function.

2) Menu setting

Anti-pass back direction

Choice of Anti-pass back mode. There are three options: In pass back, Out anti-pass back, None.

Out anti-pass back: Only the user's last recorded is IN , can open the door.

In the anti-pass back: Only the user's records in the last time is out, in order to open the door.

Device state

There are three options: control in, control out, None.

Control In: Set the value, the machine records to verify the entry records.

Control out: Set the value, the machine records to verify the records out.

None: Set the value, that is, the closure of the anti-pass back function.



Scroll ▲ / ▼ key to switch input box option, scroll ◀/▶ to change settings, after set is complete, press OK to save your settings, press "ESC" exit from the set.

3) Configure weigand output format

Two machine communication with the Wiegand signal. enter the menu of Machines -> Communications Settings -> Wiegand settings or enter the software -> basic settings -> equipment management -> weigand, "defined format" to "wiegand26 without device ID".

4) User registration

This user must exist in the client the host machine together, and users No. must be consistent . Therefore, need to register users in the host and client machine at the same time.

5) Wiring instruction

The communication between the host and client machine via the Wiegand, the wiring shows as follow:

Host machine client machine

IND0 <-----> WD0

IND1 <-----> WD1

GND <-----> GND

Appendix 7 Photo ID ★

Some equipment the Photo ID function provide , Photo ID feature is that when a user go to performances authentication, the show, names and other information screen , users photo which is stored in the U flash disk also appear on the screen.

[Steps]

1, if there is not SD card in the equipment, the steps are as follows:

- 1) Create a photo folder in the U flash disk, which is named as photo, the user's photos is stored in the folder.
- 2) User's photo must be in the JPG format, the file name must be the name of working No.. For example: The No. 154 for the corresponding photos of the user names would be 154. Jpg.
- 3) plug U flash disk into the USB slot of fingerprint machine, then proceed to verify that the user can display photos.



Note: 1) the User name is not allowed to exceed eight figures.

2), while user goes on authentication, the U flash disk have been planted on the device.

2, If the device with SD card, the steps are as follows:

1) Create a photo folder in the U flash disk, which is named as photo, the user's photos is stored in the folder..

2) User's Photo must be in the JPG format, the file name must be the name of, the User name can not be more than eight figures. For example: The No. 154 for the corresponding photos of the user names would be 154. Jpg.

3) plug U-flash disk into the USB slot of fingerprint machine, enter the U flash disk-management -> upload data -> upload user's photos. Operation is same with a 6.6 upload custom picture.

4) Download, enter the U flash disk -management -> Download -> download users pictures, a folder will be automatically build on the U flash disk -called photo , users download photos will be all existence on this folder.

RoHS Compliance

- The standard of environmental protection of these products in this statement refers to safety deadline under the conditions of provisions using the product no leakage of toxic or hazardous substances harmful to.
- The standard of environmental protection products by the deadline does not include the batteries or be easy to wear and tear of the regular replacement parts. The deadline for the use of environmentally friendly batteries is five years.

Table of hazardous substances' name and concentration

Component Name	Hazardous substances' name					
	(Pb)	(Hg)	(Cd)	(Cr6+)	(PBB)	(PBDE)
resistors	×	○	○	○	○	○
SMD capacitor	×	○	○	○	○	○
SMD inductors	×	○	○	○	○	○
SMD diode	×	○	○	○	○	○
PCB	×	○	○	○	○	○
Buzzer	×	○	○	○	○	○
Adopter	×	○	○	○	○	○
Screws	○	○	○	×	○	○

○: Indicates that this toxic or hazardous substance contained in all of the homogeneous materials for this part is below the limit requirement in SJ/T11363-2006.

X: Indicates that this toxic or hazardous substance contained in at least

one of the homogeneous materials used for this part is above the limit requirement in SJ/T11363-2006.

Note: 80% component of this product are made from non-toxic or hazardous substance, Applications of hazardous substances in this device are required to achieve its intended uses, due to lack of reasonably (economically or technically) available substitutes. Indicates that the concentration of the hazardous